



PTH PARIS TEXAS
HARDWARE™

2022 Drapery Hardware Catalog

A Modern Legacy.



Paris Texas Hardware Mission »

With a dedication to exceptional design and superior service, Paris Texas Hardware offers a unique, elegant and high quality selection of decorative drapery hardware and accessories. We believe all of our products will be unrivaled in their ability to stand alone as decorative, durable and functional. Paris Texas Hardware will offer an enjoyable customer experience that includes honest dialogue and responsive feedback.

Designed to *Inspire.*



» For over 30 years, Paris Texas Hardware has been dedicated to evolving our legacy of providing exceptional design and superior service. Our in-house design team places you at the center of the design process while staying true to our heritage of curating designs that are uniquely our own.

We respect the important relationship between style and function in design and are excited to introduce many customized solutions that are perfectly balanced to inspire your vision into a reality.

Whether it's a Modern finial silhouette that has never been seen before, a Heritage Classic with a new twist or a customized traverse solution integrated with the latest smart home technology, we promise to provide you with something different – a collective style designed to inspire that you cannot find anywhere else in the world.



Trusted Heritage

In celebration of our 30 year anniversary, we promise to deliver on our rich legacy of providing high quality products, unique & elegant designs, a wide selection of finishes and superior service combined with designer expertise to elevate your design vision.



High Quality Products

Our products are tailored specifically to your needs and designed to be unrivaled in their ability to stand alone as the perfect combination of smart, decorative, durable and functional.



Wide Selection of Finishes

With a choice between our 35 Hand Painted Portfolio Finishes, 6 Quick Ship Metal Finishes, 5 Quick Ship Wood & Resin Finishes and PTH Perfect Match™, the possibilities are endless. Our talented artisans enjoy the challenge of creating any finish that you can envision.



Available Stock | Quick Ship

When you need products to complete a project in a hurry, our Quick Ship Collection offers products that are in stock and ship within 24 hours. Available in 6 new plated metal finish options, 5 wood & resin finish options, 25 new finial designs and over 20 new bracket and accessory styles.



Superior Service

Paris Texas Hardware promises to offer an enjoyable customer experience that includes honest dialogue and responsive feedback.



Designer Expertise



Our talented team, with years of experience, are ready to help design the perfect window treatment solution for your project. Look for the icon throughout the catalog for tips, techniques and inspiration provided by our design experts, and download the full booklet using the QR code above, or by visiting: bit.ly/PTH-DE

See What's New.

Unfold this cover to see our new products, or skip to page 57 to view our new **R-TEC AUTOMATION®** collection.

Also, view our new standard finishes as you browse our product catalog.



table of contents

Portfolio Collection » *ships in 10 - 15 business days*

1 1/8" Diameter » *new*

Modern Finials	12
Clean Deco Finials	14
Transitional Luxe Finials	16
Bohemian Chic Finials	18
Rustic Retreat Finials	20
French Returns	22
Modern Metal Brackets	24
Metal Brackets	25
Poles, Rings & Accessories	26
Mix & Match	27

1 3/8" Diameter »

<i>new</i> Modern Finials	28
Today's Traditional Finials	34
Heritage Classics Finials	36
<i>new</i> French Returns	30
<i>new</i> Modern Metal Brackets	32
Metal Poles, Rings & Accessories	33
Metal Brackets	38
Wood & Resin Brackets	39
Wood Poles, Rings & Accessories	40

2 1/4" Diameter »

Today's Traditional Finials	41
Heritage Classics Finials	44
Metal Brackets	47
Wood & Resin Brackets	47
Poles, Rings & Accessories	48

Holdbacks » 50

Finishes » 52-53

Traverse Systems » *ships in 10 - 15 business days*

R-TEC AUTOMATION® » *new*

1 3/8" R-TEC Metal	60
R-TEC Heavy Duty	68
R-TEC Smart Controls	71

Somfy Motorized »

Somfy Heavy Duty	78
Somfy Controls	80

Manual » *new*

1 1/8" Metal Baton Draw	82
1 3/8" Metal Baton Draw	90
Heavy Duty Corded or Baton Draw	98

Finishes » 56

Quick Ship Collection » *ships within 24 hours*

1 1/8" Diameter » *new*

Modern Finials	108
Clean Deco Finials	110
Transitional Luxe Finials	111
Mix & Match	112
Modern Metal Brackets	113
Poles, Rings & Accessories	114
Holdbacks	115

1 3/8" Diameter »

<i>new</i> Modern Finials	116
Today's Traditional Finials	122
Heritage Classics Finials	124
<i>new</i> Modern Brackets	119
Modern Poles, Rings & Accessories	120
Modern Holdbacks	121
Metal Brackets	127
Wood & Resin Brackets	127
Wood Poles, Rings & Accessories	128
Transitional Holdbacks	129

2 1/4" Diameter »

Today's Traditional Finials	130
Heritage Classics Finials	132
Metal Brackets	134
Wood & Resin Brackets	135
Poles, Rings & Accessories	136
Holdbacks	137

Finishes » 106

See What's New.

Designed to Inspire.

Explore our 10 new Portfolio Finishes »



Stardust »



Manor »



Truffle »



Patina »



Bronzed Pewter »



Greige »



Blush »



Luminous »



Couture »



Concrete »

Our 1 1/8" Diameter Collections have finial designs you know and love, now in a larger 1 3/8" diameter + brand new designs and styles!

Mid-century design finds bold new expression in the Clean Deco Collection, featuring 8 new finial designs and a Deco Cuff / Finial Adapter.

Modern Accessories include brackets and rings to complete your Modern Style.



Mix & Match capabilities allow you to create customized mixed media combinations or add a little glamour to your finials.

Hand blown glass, clear crystal, modern acrylics, metal, wood and resin textures in rustic rush, knurled patterns and deco inspired lines combine to create mixed-media finial designs with layers of visual interest.



Our curved 1 1/8" & 1 3/8" French Return elbows with stylish mounting plates allow panels to wrap all the way to the wall for a clean transitional look and can be paired with our French Return Bands to help reduce sidelight.

Metal Traverse is available in motorized and manual options! Select from 1 3/8" Diameter R-TEC Automation® or 1 1/8" - 1 3/8" Diameter Baton Draw.

Our new R-TEC Automation® Slim Drapery Motor is designed to install effortlessly without compromising the look of your window treatment.

Our R-TEC Smart Control line allows control of window treatments from the palm of your hand or the sound of your voice, at home or away.

R-TEC AUTOMATION®

Overview of Collections + Dimension Key + Finishes

Portfolio Collection »

ships in 10 - 15 business days

The complete range of Paris Texas Hardware finials and accessories, with 7 style categories and over 200 finials, in 35 hand painted finishes.

Modern	1 1/8" DIA or 1 3/8" DIA
Clean Deco	1 1/8" DIA
Transitional Luxe	1 1/8" DIA
Bohemian Chic	1 1/8" DIA
Rustic Retreat	1 1/8" DIA
French Returns	1 1/8" DIA or 1 3/8" DIA
Today's Traditional	1 3/8" DIA or 2 1/4" DIA
Heritage Classics	1 3/8" DIA or 2 1/4" DIA

Traverse Systems »

ships in 10 - 15 business days

Motorized and Manual Systems, featuring the new **RTEC AUTOMATION™** Collection Traverse Systems with our Slim Drapery Motor, in Portfolio or Quick Ship finishes.

- RTEC** 1 3/8" Metal Motorized
- RTEC** Heavy Duty Motorized
- Somfy Heavy Duty Motorized
- 1 1/8" Baton Draw Metal Manual
- 1 3/8" Baton Draw Metal Manual
- Heavy Duty Corded or Baton Manual

Quick Ship Collection »

ships within 24 hours

A carefully edited collection of drapery hardware. And you get it fast! Orders ship within 24 hours, in 6 metal and 5 wood & resin finishes.

Modern	1 1/8" DIA or 1 3/8" DIA
Clean Deco	1 1/8" DIA
Transitional Luxe	1 1/8" DIA
Today's Traditional	1 3/8" DIA or 2 1/4" DIA
Heritage Classics	1 3/8" DIA or 2 1/4" DIA

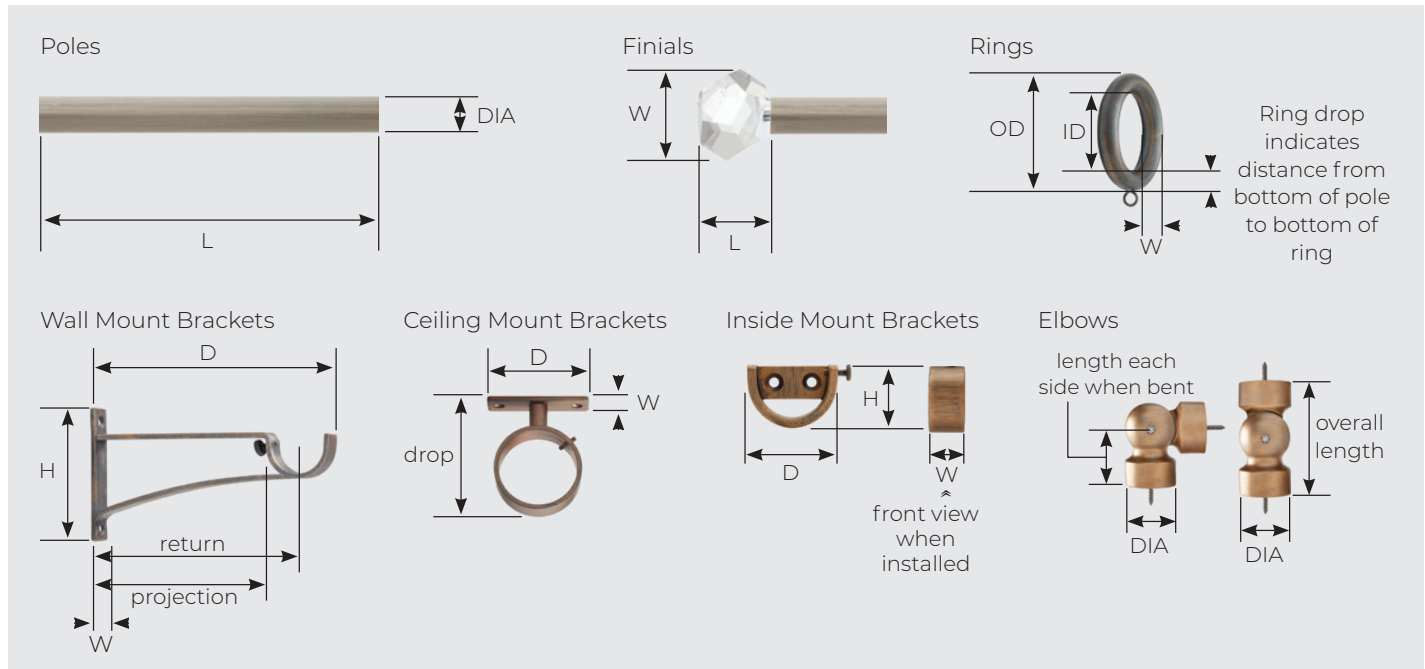

Quick Ship Metal Finishes *ships within 24 hours*



Quick Ship Wood & Resin Finishes *ships within 24 hours*

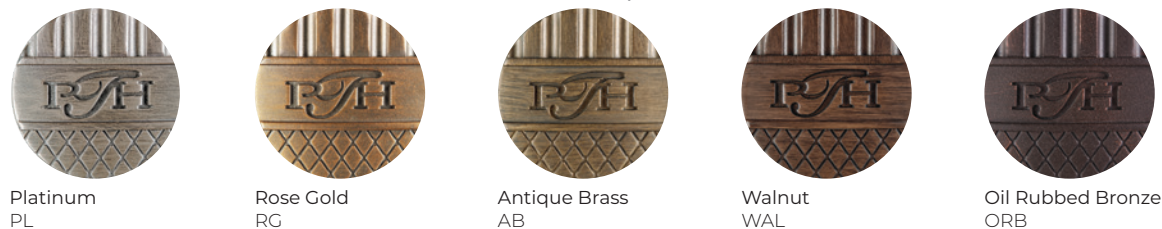

Portfolio Custom Hand Painted Finishes *ships in 10 - 15 business days*



Stardust STA



Greige GRE



Luminous LU



Truffle TRU



Bronzed Pewter BP



Patina PAT



Blush BLU



Manor MA



Concrete CO



Couture COU



Titanium TTM



Urban Bronze URB



Amulet AM



Dark Chocolate DC



Antique Gold AG



Linen LIN



Java JA



Starlet ST



Antique Gold Leaf AGL



Gossamer GOS



New Age Bronze NAB



Firelight FL



Shimmer SH



Silver Maple SM



Andiron AND



Art Bronze AB



Mystic MYS



Halo HA



Mink MK



Moonlight ML



Spicewood SPW



Barnwood BW



Spun Gold SPG



White WH



Black BL

Photography may not accurately represent the true color of a finish. A finish may show slight variation when painted on different materials, such as metal, resin or wood. For best possible finish match, please refer to the actual sample chip.

Style Guide



Style
Modern



Style
Clean
Deco



Style
Transitional
Luxe



Style
Bohemian
Chic



Style
Rustic
Retreat



Style
Today's
Traditional



Style
Heritage
Classics

Style to Inspire.

A style designed to
enhance any lifestyle.



Portfolio Custom Hand Painted Finishes

ships in 10 - 15 business days



Stardust STA



Greige GRE



Luminous LU



Truffle TRU



Bronzed Pewter BP



Patina PAT



Blush BLU



Manor MA



Concrete CO



Couture COU



Titanium TTM



Urban Bronze URB



Amulet AM



Dark Chocolate DC



Antique Gold AG



Linen LIN



Java JA



Starlet ST



Antique Gold Leaf AGL



Gossamer GOS



New Age Bronze NAB



Firelight FL



Shimmer SH



Silver Maple SM



Andiron AND



Art Bronze AB



Mystic MYS



Halo HA



Mink MK



Moonlight ML



Spicewood SPW



Barnwood BW



Spun Gold SPG



White WH



Black BL

PTH Perfect Match™ » thousands of Benjamin Moore® colors, see page 54

For your convenience, you can unfold the back cover to view our 35 hand painted Portfolio finishes as you browse.



 **Designer Expertise**

Make short windows look taller by adding a stationary shade valance on top, flanked by tall drapery panels »

For shade system solution options, visit the Rowley Company website at: bit.ly/custom-shade-solutions

Finish »
Art Bronze



Style
Modern



1 1/8" Modern Finial Collection new

Inspiring a Modern lifestyle, the updated 1 1/8" Modern Collection is defined by clean lines, contemporary materials and sophisticated silhouettes designed with an approachable appeal. Available in any of our 35 Portfolio Hand Painted Finishes or PTH Perfect Match™. 1 1/8" Finials require a cuff / finial adapter to work with 1 1/8" Metal Traverse. See pages 82 - 89.

Explore the Style »



1 1/8" Modern Finial Collection *new*



new Emery End Cap
PO118EMEC
3/4" L x 1 1/4" W
Metal, Blush



new Evan End Cap
PO118EVEC
3/4" L x 1 3/4" W
Metal, Amulet



new Ryder - Crystal
PO118RYFI
1 3/4" L x 1 3/4" W
Metal / Crystal, Art Bronze



new Reese - Crystal
PO118REFI
2 3/4" L x 2 1/2" W
Crystal, Metal Pole shown in Halo



new London - Crystal
PO118LOFI
1 7/8" L x 3" W
Metal / Crystal, Black



Knox - Crystal
PO118KNFI
1 1/4" L x 2 5/8" W
Crystal, Metal Pole shown in Stardust





Ella
PO118ELAFI
1 5/8" L x 1 5/8" W
Metal, Andiron



Elm
PO118EMFI
1 1/8" L x 2" W
Metal, Mystic



Elm - Smoke Glass
PO118EMFIGL
1 1/8" L x 2" W
Metal / Glass, Bronzed Pewter



Cole
PO118COFI
3 1/4" L x 1 1/2" W
Metal, Dark Chocolate



Lex
PO118LXFI
1 7/8" L x 2" W
Metal, Firelight



Modern Finish
Highlight »
Halo & Black



Finial Accessories

Dress up your 1 1/8" finial or pole with our Mix & Match accessories. See page 27.



new 1 1/8" Transitional Cuff / Finial Adapter
PO118CUFF
3/4" L x 1 1/4" W
Metal, Blush



Reese - Crystal Finial
with Transitional Cuff
in Blush finish



new 1 1/8" Deco Cuff / Finial Adapter
PO118DECUFF
3/4" L x 1 3/8" W
Metal, Shimmer on Art Bronze pole



Ryder - Crystal Finial in
Art Bronze finish with Deco
Cuff in Shimmer finish

Style Meets Function

1 1/8" Finials require a cuff / finial adapter to work with 1 1/8" Metal Traverse. See pages 82 - 89.



Ella Finial with Finial Adapter
in Andiron finish

Style
Clean
Deco



Finish 
Antique
Gold

1 1/8" Clean Deco Finial Collection new

Mid-century design finds bold new expression in the Clean Deco Collection, featuring 8 new finial designs and a Deco Cuff / Finial Adapter. Available in any of our 35 Portfolio Hand Painted Finishes or PTH Perfect Match™. 1 1/8" Finials require a cuff / finial adapter to work with 1 1/8" Metal Traverse. See pages 82 - 89.

[Explore the Style »](#)



1 1/8" Clean Deco Finial Collection *new*



new Deco End Cap
PO118DEEC
3/4" L x 1 3/8" W
Metal, Couture



new Zane End Cap
PO118ZAEC
5/8" L x 2 3/8" W
Metal, Black



new Wright - Crystal
PO118WIFI
2 1/2" L x 2 3/4" W
Metal / Crystal, Starlet



new Viktor
PO118VIFI
1 1/2" L x 2 3/4" W
Metal / Acrylic, Black





new Neve - Crystal
PO118NVFI
2 1/2" L x 2" W
Metal / Crystal, Antique Gold



new Wren
PO118WRFI
2" L x 1 7/8" W
Metal, Java

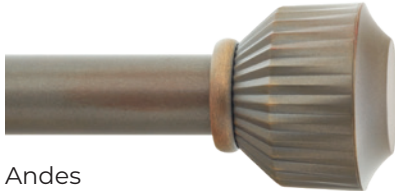

new Dakota - Crystal
PO118DAFI
2 3/4" L x 2 1/2" W
Metal / Crystal, Urban Bronze

new Andes
PO118ANFI
2 1/2" L x 2 5/8" W
Metal, Andiron



new Penelope
PO118PEFI
1 1/8" L x 2 3/4" W
Metal, Art Bronze



Clean Deco
Finish Highlight »
Black



Finial Accessories

Dress up your 1 1/8" finial or pole with our Mix & Match accessories. See page 27.



new 1 1/8" Transitional Cuff / Finial Adapter
PO118CUFF
3/4" L x 1 1/4" W
Metal, Antique Gold



Viktor Finial with
Transitional Cuff in
Antique Gold finish



new 1 1/8" Deco Cuff / Finial Adapter
PO118DECUFF
3/4" L x 1 3/8" W
Metal, Art Bronze



Penelope Finial with Deco
Cuff in Art Bronze finish

Style Meets Function

1 1/8" Finials require a cuff / finial adapter to work with 1 1/8" Metal Traverse. See pages 82 - 89.



Zane End Cap in Black finish
with Deco Finial Adapter in
Antique Gold finish

Style
Transitional
Luxe



1 1/8" Transitional Luxe Finial Collection new

Luxe, sophisticated and of the moment, create endlessly elegant drapery hardware designs with a thoughtfully curated mix of classic and modern details. Available in any of our 35 Portfolio Hand Painted Finishes or PTH Perfect Match™. 1 1/8" Finials require a cuff / finial adapter to work with 1 1/8" Metal Traverse. See pages 82 - 89.

Explore the Style »



1 1/8" Transitional Luxe Finial Collection *new*



new Hudson End Cap
PO118HUEC
7/8" L x 1 7/8" W
Resin, Barnwood



Beale End Cap
PO118BEEC
1/2" L x 2" W
Resin, Andiron



new Kensington - Crystal
PO118KEFI
2 5/8" L x 2 5/8" W
Resin / Crystal, Luminous



new Callie
PO118CAFI
1 1/2" L x 2 5/8" W
Resin, Black

top view showing marble finish



new Nola
PO118NLF1
2 3/4" L x 2 3/8" W
Resin, Titanium



new Jules
PO118JUF1
2 7/8" L x 2 3/4" W
Resin, Greige



Nora
PO118NOFI
2 1/8" L x 2 3/8" W
Metal, Luminous



Fairbanks
PO118FBFI
3 1/4" L x 2" W
Resin, Mystic



new Piper
PO118PIFI
3 1/8" L x 2 5/8" W
Resin / Glass, Antique Gold Leaf



Nora - Mercury Glass
PO118NOFIGL
2 1/8" L x 2 3/8" W
Metal / Glass, Black



Transitional Luxe
Finish Highlight »

**Luminous &
Urban Bronze**



Finial Accessories

Dress up your 1 1/8" finial or pole with our Mix & Match accessories. See page 27.



new 1 1/8" Transitional Cuff / Finial Adapter
PO118CUFF
3/4" L x 1 1/4" W
Metal, Black



Callie Finial with Transitional
Cuff in Black finish



new 1 1/8" Deco Cuff / Finial Adapter
PO118DECUFF
3/4" L x 1 3/8" W
Metal, Antique Gold on Luminous pole



Kensington - Crystal Finial in
Luminous finish with Deco
Cuff in Antique Gold finish

Style Meets Function

1 1/8" Finials require a cuff / finial adapter to work with 1 1/8" Metal Traverse. See pages 82 - 89.



Jules Finial with Finial Adapter
in Greige finish

1 1/8" Bohemian Chic Finial Collection *new*

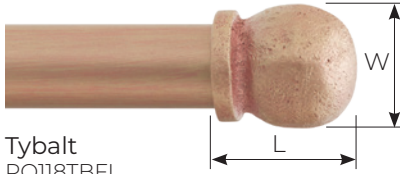

Tybalt
PO118TBFI
2" L x 1 5/8" W
Resin, Blush



new **Monet**
PO118MOFI
2 1/4" L x 2 7/8" W
Resin, Titanium



new **Phoebe**
PO118PHFI
2 3/8" L x 3" W
Resin / Glass, Mink



Astor
PO118ASFI
1 3/8" L x 2 1/4" W
Resin, Amulet



Achilles
PO118ACFI
4 1/8" L x 1 7/8" W
Resin, Urban Bronze



Nerissa
PO118NEFI
4 1/2" L x 3 3/8" W
Resin, Firelight

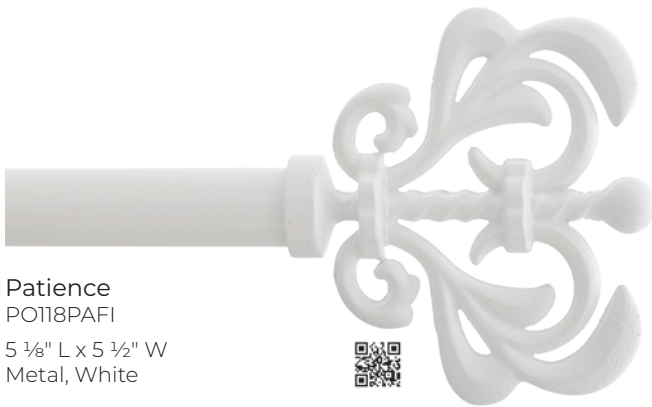

Patience
PO118PAFI
5 3/8" L x 5 1/2" W
Metal, White



Bohemian Chic
Finish Highlight »
Blush



Finial Accessories

Dress up your 1 1/8" finial or pole with our Mix & Match accessories. See page 27.



new **1 1/8" Transitional Cuff / Finial Adapter**
PO118CUFF
3/4" L x 1 1/4" W
Metal, Blush



Monet Finial with
Transitional Cuff in
Blush finish



new **1 1/8" Deco Cuff / Finial Adapter**
PO118DECUFF
3/4" L x 1 3/8" W
Metal, Greige on Mink pole



Phoebe Finial in Mink finish
with Deco Cuff in Greige finish

Style Meets Function

1 1/8" Finials require a cuff / finial adapter to work with 1 1/8" Metal Traverse. See pages 82 - 89.

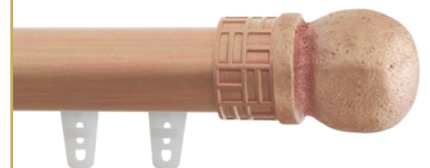

Tybalt Finial with Deco Finial
Adapter in Blush finish

Style
Rustic
Retreat



1 1/8" Rustic Retreat Finial Collection new

Rooted in nature and inspired by natural elements, our beautifully crafted Rustic Retreat Collection inspires your window with a refreshing mix of rich textures and finish options. Available in any of our 35 Portfolio Hand Painted Finishes or PTH Perfect Match™. 1 1/8" Finials require a cuff / finial adapter to work with 1 1/8" Metal Traverse. See pages 82 - 89.

Explore the Style »



1 1/8" Rustic Retreat Finial Collection new



new **Lena End Cap**
PO118LEEC
3/4" L x 1 1/2" W
Resin, Starlet



new **Cheyenne - Crystal**
PO118CHFI
2 1/2" L x 2 1/2" W
Metal / Crystal, Stardust



new **Annabel**
PO118AAFI
2" L x 2 1/2" W
Resin, Shimmer



new **Finley**
PO118FIFI
3" L x 2 3/4" W
Resin, Linen



new **Stowe**
PO118STFI
2 1/4" L x 3 3/8" W
Resin, Gossamer



new **Rhea**
PO118RHF
2" L x 2 7/8" W
Resin, Bronzed Pewter



new **Kane**
PO118KAFI
2 1/2" L x 2 1/4" W
Resin, Concrete



new **Ash**
PO118AHFI
3 3/4" L x 2 1/4" W
Resin, Spun Gold



Rustic Retreat
Finish Highlight »
**Greige &
Barnwood**



Finial Accessories

Dress up your 1 1/8" finial or pole with our Mix & Match accessories. See page 27.



new **1 1/8" Transitional Cuff / Finial Adapter**
PO118CUFF
3/4" L x 1 1/4" W
Metal, Antique Gold on Stardust pole



Cheyenne - Crystal Finial
in Stardust finish with
Transitional Cuff in Antique Gold finish



new **1 1/8" Deco Cuff / Finial Adapter**
PO118DECUFF
3/4" L x 1 3/8" W
Metal, Concrete



**Kane Finial with Deco
Cuff in Concrete finish**

Style Meets Function

1 1/8" Finials require a cuff / finial adapter to work with 1 1/8" Metal Traverse. See pages 82 - 89.



**Rhea Finial with Transitional
Finial Adapter in Bronzed
Pewter finish**

Style
Modern



Finish »
Black



1 1/8" French Returns Collection new

Reduce sidelight with the clean, modern look of 1 1/8" French Returns. Our NEW curved French Return brackets with stylish Round or Square mounting plates and return bands allow panels to wrap around securely to the wall, creating a more refined elegance. Available in any of our 35 Portfolio Hand Painted Finishes or PTH Perfect Match™.

Explore the Style »



1 1/8" French Returns new



new French Return with Square Mount Plate
(Includes Pole Splice; Metal Pole sold separately)
PO118MEFRS

3 1/2" return, 5 1/2" L, 2 3/16" backplate square,
3/8" plate thickness
Metal, Halo



new French Return with Round Mount Plate
(Includes Pole Splice; Metal Pole sold separately)
PO118MEFRR

3 1/2" return, 5 1/2" L, 2 3/16" backplate DIA,
3/8" plate thickness
Metal, Black



Finishes »
Halo & Black



1 1/8" French Return Brackets & Accessories new

French Returns include pole splices. Metal poles sold separately. See page 26. Pair with coordinating rings and brackets.



new Declan Single
PO118DESBK
2" DIA backplate, 3 1/2" return
Metal, Halo



new Axel Single
PO118AXSBK
2" DIA backplate, 3 1/2" return
Metal, Halo



new Aiden Single
PO118AESBK
2" DIA backplate, 3 1/2" return,
use with Caden C-Rings
Metal, Halo



Laurence Single
PO118LASBK
3/4" W x 3 3/4" H backplate,
3 1/2" return
Metal, Halo



Gregory Single
PO118GRSBK
3/4" W x 3 3/4" H backplate,
3 1/2" return,
use with Small C-Rings
Metal, Halo



new Gregory Horizontal Single
PO118GRSHBK
3/4" W x 3 3/4" H backplate,
3 1/2" return,
use with Small C-Rings
Metal, Halo



new French Return Band
PO118MEFRBAND
Bands can be used to secure the
drapery ensuring minimal light gap
or to cover the seams of the pole.
Metal, Halo



new Adjustable Single Bracket
POBKT118
1" W x 3 1/4" H backplate,
3 1/2" return
Metal, Halo



new Austin Ring
PO118AURI
1 1/4" ID, 1 5/8" OD,
3/4" drop
Metal, Halo



new Caden C-Ring
PO118CACRI
1 1/4" ID, 1 5/8" OD,
3/4" drop, use with
Aiden brackets
Metal, Halo



Swing Ring
PO118SWRI
1 1/4" ID, 1 5/8" OD,
5/8" drop
Metal, Halo



Small C-Ring
PO118SCRI
1 1/4" ID, 1 5/8" OD, 5/8" drop,
use with Gregory brackets
Metal, Halo

Aiden or Gregory bypass brackets and coordinating C-Rings allow continuous ring movement along the length of your drapery rod »



Designer Expertise



1 1/8" Modern Metal Brackets *new*



new Declan Single
PO118DESBK
2" DIA backplate, 3 1/2" return
Metal, Halo



new Declan 6" Single
PO118DES6BK
2" DIA backplate, 6" return
Metal, Halo



new Declan Double
PO118DEDDBK
2" DIA backplate, 6 1/2" front return
and 3 1/2" back return
Metal, Halo



new Axel Single
PO118AXSBK
2" DIA backplate, 3 1/2" return
Metal, Halo



new Axel 6" Single
PO118AXS6BK
2" DIA backplate, 6" return
Metal, Halo



new Axel Double
PO118AXDBK
2" DIA backplate, 6 1/2" front return
and 3 1/2" back return
Metal, Halo



new Aiden Single
PO118AESBK
2" DIA backplate,
3 1/2" return, use with
Caden C-Rings
Metal, Halo



new Aiden Double
PO118AEDBK
2" DIA backplate, 6 1/2" front return and
3 1/2" back return, 3/16" clearance above
backplate, use with Caden C-Rings
Metal, Halo



new Inside Mount
(sold in pairs)
PO118IMBK
1 13/16" DIA backplate x
1 1/4" D, 3/16" thick backplate
per bracket
Metal, Halo

Finish »
Halo



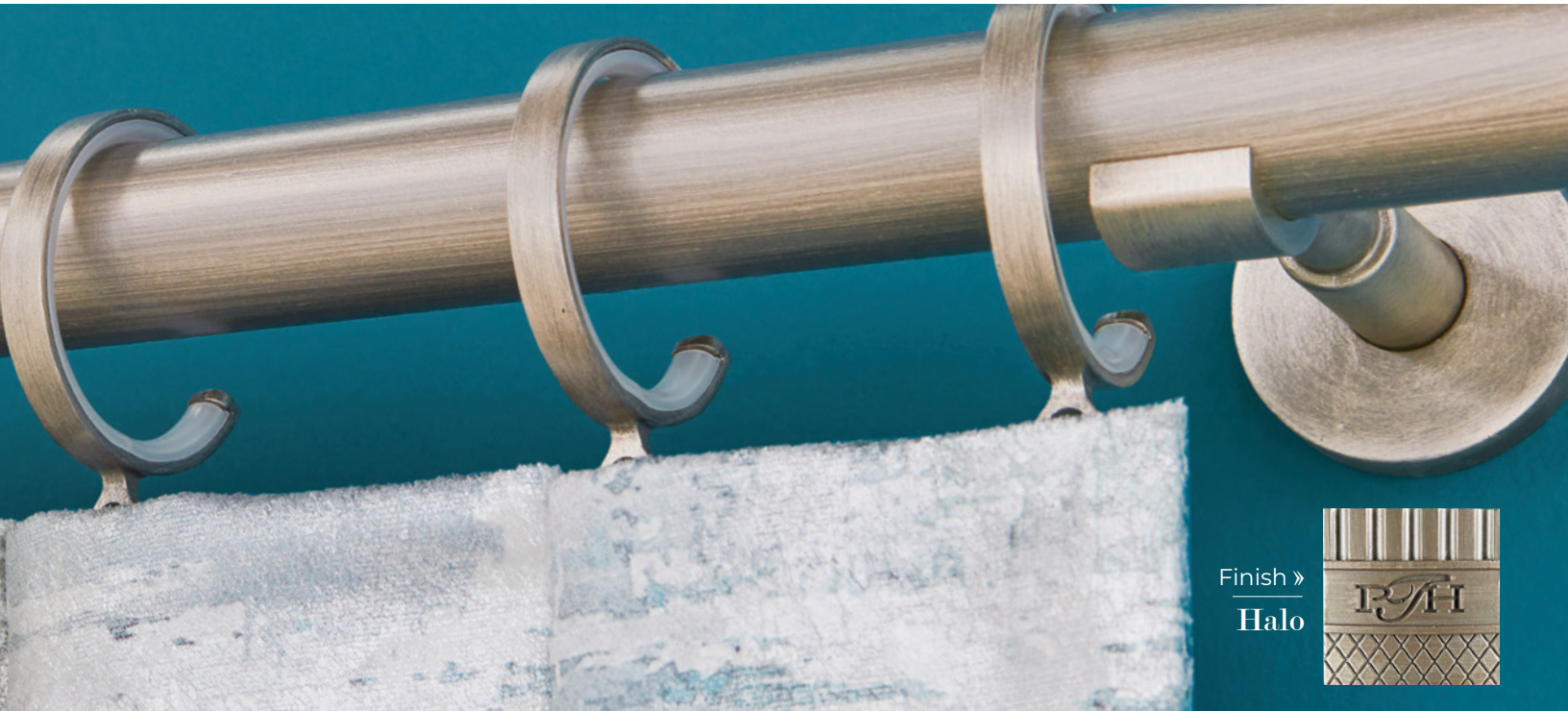

Finish »
Halo



1 1/8" Metal Brackets



Laurence Single
PO118LASBK
3/4" W x 3 3/4" H backplate, 3 1/2" return
Metal, Luminous



Laurence 6" Single
PO118LAS6BK
3/4" W x 3 3/4" H backplate, 6" return
Metal, Luminous



Laurence Double
PO118LADBK
3/4" W x 3 3/4" H backplate, 6" front return and 3" back return
Metal, Luminous



Gregory Single
PO118GRSBK
3/4" W x 3 3/4" H backplate, 3 1/2" return, use with Small C-Rings
Metal, Luminous



Gregory 6" Single
PO118GRS6BK
3/4" W x 3 3/4" H backplate, 6" return, use with Small C-Rings
Metal, Luminous



Gregory Double
PO118GRDBK
3/4" W x 3 3/4" H backplate, 6" front return and 3" back return, use with Small C-Rings
Metal, Luminous



Gregory Horizontal Single PO118GRSHBK
2 3/8" W x 3/4" H backplate, 3 1/2" return, use with Small C-Rings
Metal, Luminous



Adjustable Single Bracket
POBKT118
1" W x 3 1/4" H backplate, adjustable 3 1/2" - 5" return
Metal, Luminous



Ceiling Single
PO118MCMBK
2" DIA backplate, 1 5/8" drop
Metal, Luminous

Finish »
Luminous



Portfolio: 1 1/8"

1 1/8" Metal Pole new

1 1/8" metal poles are sold in 2' increments. 2' minimum. Poles will be cut to specified lengths; fall off will not be saved or shipped. Maximum continuous length up to 12'. 1 1/8" metal poles are supplied with plastic inserts to attach the finials.



new Metal Pole
PO118ME
Metal, Couture

Style Meets Function

1 1/8" Finials require a cuff / finial adapter to work with 1 1/8" Metal Traverse. See pages 82 - 89.



Ella Finial with Finial Adapter in Andiron finish

1 1/8" Metal Rings

Ring Drop indicates distance from bottom of pole to bottom of ring.



Swing Ring
PO118SWRI
1 1/4" ID, 1 5/8" OD, 5/8" drop
Metal, Couture



Small C-Ring
PO118SCRI
1 1/4" ID, 1 5/8" OD, 5/8" drop,
use with Gregory brackets
Metal, Couture



new Austin Ring
PO118AURI
1 1/4" ID, 1 5/8" OD, 3/4" drop
Metal, Couture



new Caden C-Ring
PO118CACRI
1 1/4" ID, 1 5/8" OD, 3/4" drop,
use with Aiden brackets
Metal, Couture

1 1/8" Metal Accessories



Metal Batons
36" POME36WAND
48" POME48WAND
60" POME60WAND
3/8" DIA, Metal, Couture



Clear Acrylic Batons
36" AC36WAND
48" AC48WAND
60" AC60WAND
1/2" DIA, Acrylic



new Handicap Metal Batons
48" POME48HWAND
60" POME60HWAND
4" Loop, ADA Compliant, Metal, Couture



new Handicap Clear Acrylic Batons
48" AC48HWAND
60" AC60HWAND
72" AC72HWAND
4" Loop, ADA Compliant, Acrylic



new Hinged Elbow
PO118MEL
1 1/8" DIA, 2 7/8" overall length,
1 3/4" L each side when bent
Metal, Couture



new Pole Splice
PSME118403
4 5/8" L, must be ordered
separately

Finish »
Couture



Transitional Style

Use a 1 1/8" or 1 3/8" Transitional Cuff / Finial Adapter to adapt your finials to the metal traverse systems, or use the cuffs to mix & match finishes and customize your design.

new 1 1/8" Transitional Cuff / Finial Adapter
PO118CUFF
3/4" L x 1 1/4" W
Metal, Blush on Metal Traverse with Reese - Crystal Finial

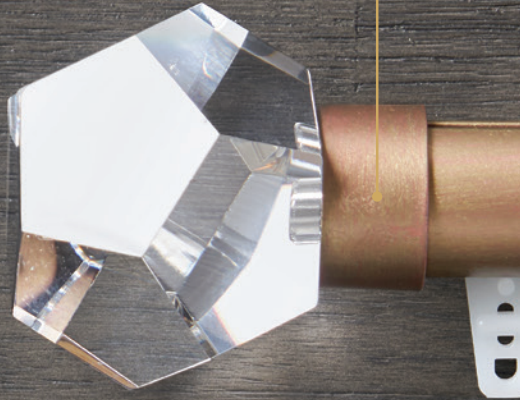

Need Some Glamour?

Pair a 1 1/8" Crystal Band with your favorite 1 1/8" finial



1 1/8" Crystal Band
PO118CRMEBAND
3/4" L x 1 1/4" W
Dark Metal with Inlaid Crystals on Black Metal Pole with Zane End Cap



Designer Expertise

Place Crystal Bands anywhere along the pole for extra customization - there's no limit! »



Clean Deco Style

Upgrade your finial with the 1 1/8" Deco Cuff / Finial Adapter to create deco-inspired style, or to adapt your finials to the metal traverse systems

new 1 1/8" Deco Cuff / Finial Adapter
PO118DECUFF
3/4" L x 1 3/8" W
Metal, Antique Gold on Luminous Metal Pole with Kensington - Crystal Finial - mix & match finishes!

Mix & Match

Create an even more *customized* design »

How To Add Your Band or Cuff »



1 Select your Cuff style and finish - Mix & Match for the ultimate customization.



2 Place Cuff onto metal pole and tighten set screw with Allen Wrench.



3 Install finials by screwing into the Cuff / Finial Adapter.

Style Meets Function

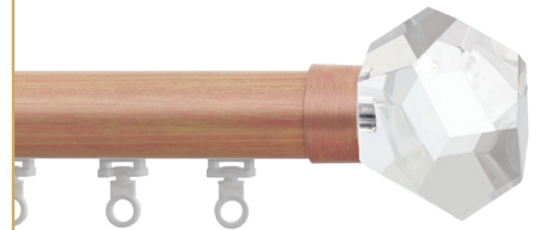

1 1/8" Finials require a cuff / finial adapter to work with 1 1/8" Metal Traverse.
See pages 82 - 89.

Style
Modern



1 3/8" Modern Finial Collection *new*

Inspiring a Modern lifestyle, the updated 1 3/8" Modern Collection is defined by clean lines, contemporary materials and sophisticated silhouettes designed with an approachable appeal. Available in any of our 35 Portfolio Hand Painted Finishes or PTH Perfect Match™.

Explore the Style »



1 3/8" Modern Finial Collection new



new **Ainsley End Cap**
PO138AIEC
3/4" L x 1 1/2" W
Metal, Antique Gold Leaf



new **Asher End Cap**
PO138ASEC
1" L x 2 1/4" W
Metal, Java



new **Quinn**
PO138QUFI
1 3/4" L x 2 1/4" W
Metal, Shimmer



new **Adair**
PO138ADFI
3 3/8" L x 3" W
Metal, Starlet



new **Sterling - Crystal**
PO138STFI
2 3/4" L x 3" W
Metal / Crystal, Silver Maple



new **Remi - Crystal**
PO138REFI
3 1/4" L x 3" W
Metal / Crystal, Manor



new **Cohen**
PO138COFI
1 7/8" L x 3 3/8" W
Metal / Clear Acrylic, Stardust



new **Exton**
PO138EXFI
2 3/4" L x 2 1/4" W
Metal, Black



new **Zara**
PO138ZAFI
2 1/2" L x 3 1/2" W
Metal / Clear Acrylic, Couture



new **London - Crystal**
PO138LOFI
2 5/8" L x 3 3/8" W
Metal / Crystal, Moonlight



Modern Finish
Highlight »
Halo & Black



Style Meets Function

1 3/8" Modern Finials work with 1 3/8" **RTEC** AUTOMATION[®] Metal Traverse on pages 60 - 67 and 1 3/8" Metal Baton Draw Traverse on pages 90 - 97.

*1 3/8" Modern Finials are designed to attach directly to the Metal Traverse rod with a set screw. Transitional Cuff / Finial Adapter is not required.

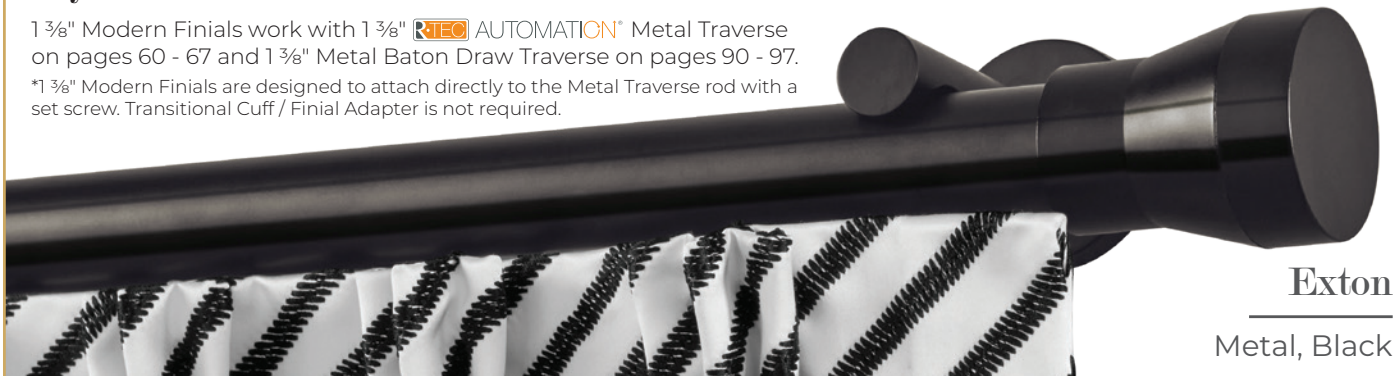

Exton
Metal, Black

Style
Modern



1 3/8" French Returns Collection new

Reduce sidelight with the clean, modern look of 1 3/8" French Returns. Our NEW curved French Return brackets with stylish Round or Square mounting plates and return bands allow panels to wrap around securely to the wall, creating a more refined elegance. Available in any of our 35 Portfolio Hand Painted Finishes or PTH Perfect Match™.

Explore the Style »



1 3/8" French Returns new

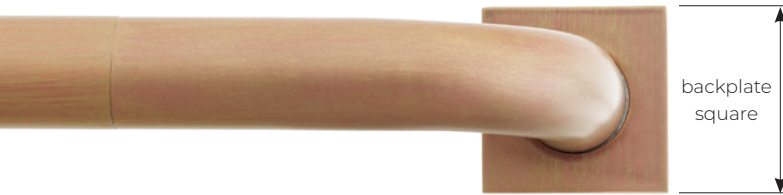

new French Return with Square Mount Plate
 (Includes Pole Splice; Metal Pole sold separately)
 PO138MEFRS
 3 1/2" return, 5 1/2" L, 2 7/16" backplate W, 3/8" plate thickness
 Metal, Blush



new French Return with Round Mount Plate
 (Includes Pole Splice; Metal Pole sold separately)
 PO138MEFRR
 3 1/2" return, 5 1/2" L, 2 7/16" backplate DIA, 3/8" plate thickness
 Metal, Black



1 3/8" French Return Brackets & Accessories new

French Returns include pole splices. Metal poles sold separately. See page 32. Pair with coordinating rings and brackets.

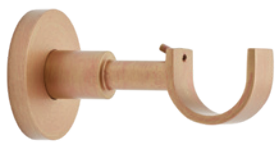

new Grant Single
 PO138GASBK
 2 1/2" DIA backplate, 3 1/2" return
 Metal, Blush



Winston Single
 PO138WSSBK
 3/4" W x 3 3/4" H backplate, 3 1/2" return
 Metal, Blush



new Adjustable 3 1/2" - 5" Single
 POBKT138
 1" W x 3 1/4" H backplate, 3 1/2" return
 Metal, Blush

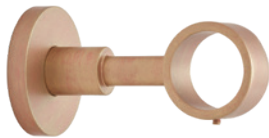

new Gage Single
 PO138GGSBK
 2 1/2" DIA backplate, 3 1/2" return
 Metal, Blush

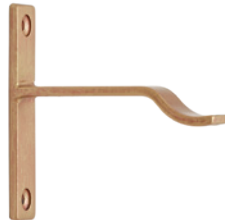

Gregory Single
 PO138GRSBK
 3/4" W x 3 3/4" H backplate, 3 1/2" return,
 use with Medium C-Rings
 Metal, Blush



new French Return Band
 PO138MEFRBAND
 Bands can be used to secure the drapery ensuring minimal light gap or to cover the seams of the pole.
 Metal, Blush

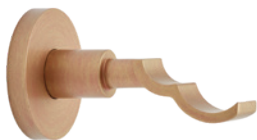

new Talon Single
 PO138TASBK
 2 1/2" DIA backplate, 3 1/2" return, use with Calla C-Rings
 Metal, Blush



new Gregory Horizontal Single
 PO138GRSHBK
 2 3/8" W x 3/4" H backplate, 3 1/2" return, use with Medium C-Rings
 Metal, Blush



new Rowan Ring
 PO138RORI
 2" ID, 2 3/8" OD,
 3/4" drop
 Metal, Blush



new Calla C-Ring
 PO138CLCRI
 2" ID, 2 3/8" OD,
 3/4" drop, use with
 Talon brackets
 Metal, Blush



Metal Ring
 PO138MRI
 1 3/4" ID, 2 1/4" OD,
 5/8" drop
 Metal, Blush



Medium C-Ring
 PO138MCRI
 2" ID, 2 3/8" OD, 3/4" drop,
 use with Gregory brackets.
 Metal, Blush

Finish »
Blush



Portfolio: 1 3/8"

1 3/8" Modern Metal Brackets *new*



new Grant Single
PO138GASBK
2 1/2" DIA backplate, 3 1/2" return
Metal, Patina



new Grant 6" Single
PO138GAS6BK
2 1/2" DIA backplate, 6" return
Metal, Patina



new Grant Double
PO138GADBK
2 1/2" DIA backplate, 6 1/2" front return and
3 1/2" back return
Metal, Patina



new Gage Single
PO138GGSBK
2 1/2" DIA backplate, 3 1/2" return
Metal, Patina



new Gage 6" Single
PO138GGS6BK
2 1/2" DIA backplate, 6" return
Metal, Patina

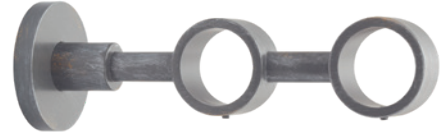

new Gage Double
PO138GGDBK
2 1/2" DIA backplate, 6 1/2" front return and
3 1/2" back return
Metal, Patina



new Talon Single
PO138TASBK
2 1/2" DIA backplate, 3 1/2" return,
use with Calla C-Rings
Metal, Patina



new Talon Double
PO138TADBK
2 1/2" DIA backplate, 6 1/2" front return and
3 1/2" back return, 3/8" clearance above
backplate, use with Calla C-Rings
Metal, Patina

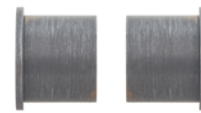

new Inside Mount
PO138IMBK
2" DIA backplate x 1 9/16" D,
1/4" thick backplate per bracket
Metal, Patina

Finish »
Patina



1 3/8" Metal Pole | 1 3/8" Acrylic Pole

1 3/8" metal and acrylic poles are sold in 2' increments. 2' minimum. Poles will be cut to specified lengths; fall off will not be saved or shipped. Maximum continuous length up to 12' on metal poles. 1 3/8" metal poles are supplied with plastic inserts to attach to wood & resin finials, if desired. Acrylic poles only work with the 1 3/8" Modern Finial Collection. Maximum continuous length up to 12' on acrylic poles; cannot be spliced.



Metal Pole
PO138ME
Metal, Amulet



Acrylic Pole
PO138AC
Clear Acrylic

Style Meets Function

1 3/8" Modern Finials work with 1 3/8" **RTEC** AUTOMATION® Metal Traverse on pages 60 - 67 and 1 3/8" Metal Baton Draw Traverse on pages 90 - 97.



1 3/8" Metal Rings new

Ring Drop indicates distance from bottom of pole to bottom of ring.



new **Rowan Ring**
PO138RORI
2" ID, 2 3/8" OD, 3/4" drop
Metal, Amulet



new **Calla C-Ring**
PO138CLCRI
2" ID, 2 3/8" OD, 3/4" drop,
use with Talon brackets
Metal, Amulet

1 3/8" Metal Accessories



Metal Batons
36" POME36WAND
48" POME48WAND
60" POME60WAND
3/8" DIA, Metal, Amulet



Clear Acrylic Batons
36" AC36WAND
48" AC48WAND
60" AC60WAND
1/2" DIA, Acrylic



new **Handicap Metal Batons**
48" POME48HWAND
60" POME60HWAND
4" Loop, ADA Compliant, Metal, Amulet



new **Handicap Clear Acrylic Batons**
48" AC48HWAND
60" AC60HWAND
72" AC72HWAND
4" Loop, ADA Compliant, Acrylic



new **Hinged Elbow**
PO138MEL
1 3/8" DIA, 2 7/8" overall
length, 2" L each side
when bent
Metal, Amulet



new **Pole Splice**
PSME138403
4 3/4" L, must be ordered separately

Finish »
Amulet



Style
Today's
Traditional



1 3/8" Today's Traditional Finial Collection

Purposefully designed with a minimalist elegance that reflects a modern interpretation of classic style with an uncompromising attention to every detail and material, the Today's Traditional Collection elevates timeless window design. Available in any of our 35 Portfolio Hand Painted Finishes or PTH Perfect Match™.

Explore the Style »



1 3/8" Today's Traditional Finial Collection



Essex End Cap
PO138ESEC

3/4" L x 2" W
Resin, Linen



Aubrie End Cap
PO138AUEC

3/4" L x 2 1/4" W
Resin, Titanium



Rose - Crystal
PO138ROFI

2 1/2" L x 2 3/4" W
Resin / Crystal, Blush



Bradford
PO138BRFI

3 1/4" L x 2 1/4" W
Resin, Luminous



Leo
PO138LEFI

3 1/2" L x 2 3/4" W
Resin, Moonlight



Everette
PO138EVFI

2 7/8" L x 3 1/4" W [2 1/2" square]
Resin, Halo

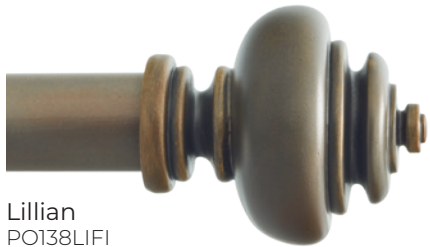

Lillian
PO138LIFI

4" L x 3 3/8" W
Resin, Andiron



Lyla
PO138LYFI

2 5/8" L x 2 3/4" W
Resin, Firelight



June
PO138JUFI

2 3/4" L x 2 5/8" W
Resin, Urban Bronze



Lillian - Mercury
Glass PO138LIFIGL

4" L x 3 3/8" W
Resin / Glass, Java



Today's Traditional
Finish Highlight »
**Luminous &
Truffle**



Finial Accessories

Dress up your 1 3/8" finial with our Transitional Cuff.

new 1 3/8" Transitional Cuff / Finial Adapter

PO138CUFF

3/4" L x 1 1/2" W

- Metal, Available in any of our 35 Portfolio Hand Painted Finishes
- Mix & Match finishes and materials for the ultimate customized style, or use to adapt your 1 3/8" Today's Traditional Finial to work with R-TEC Automation® Metal Traverse on pages 60 - 67 and Baton Draw Metal Traverse on pages 90 - 97



new 1 3/8" Transitional Cuff / Finial Adapter

PO138CUFF

3/4" L x 1 1/2" W

Metal, Blush



Rose - Crystal Finial
with Transitional Cuff in
Blush finish

Style Meets Function

1 3/8" Today's Traditional Finials work with 1 3/8" Metal Traverse using the Finial Adapter. See pages 60 - 67.



Lillian Finial with Transitional
Cuff in Andiron finish

Style
Heritage
Classics



1 3/8" Heritage Classics Finial Collection

Our Heritage Classics Style may be a new category, but this collection features new finial designs as well as Paris Texas Hardware classics that have been favorites throughout the years. With ornate details and Old World design, these are sure to make a big statement for your windows. Available in any of our 35 Portfolio Hand Painted Finishes or PTH Perfect Match™.

Explore the Style »



1 3/8" Heritage Classics Finial Collection



Lowell End Cap
PO138LOEC
1" L x 2" W
Resin, Spun Gold



Blythe
PO138BYFI
3 5/8" L x 2 7/8" W
Metal / Glass, Antique Gold Leaf



Adele
PO138AEFI
3 5/8" L x 2 5/8" W
Metal / Glass, Andiron



Severn
PO138SEFI
3 3/4" L x 3" W
Resin, Java



Harper
PO138HAFI
3" L x 2 3/4" W
Resin, Shimmer



Lane
PO138LAFI
3 5/8" L x 3 1/2" W
Resin, Urban Bronze



Avon
PO138AVFI
3 5/8" L x 3 3/4" W
Resin, White



Gaston
PO138GSFI
3 5/8" L x 3 3/8" W
Resin, Antique Gold



Brielle
PO138BLFI
4" L x 3" W
Resin, Luminous



Amboise
PO138AMFI
5 1/4" L x 2 7/8" W
Resin, Amulet



Heritage Classics
Finish Highlight »
**Antique Gold
Leaf**



Finial Accessories

Dress up your 1 3/8" finial with our Transitional Cuff.

- 1 3/8" Transitional Cuff / Finial Adapter**
PO138CUFF
3/4" L x 1 1/2" W
- Metal, Available in any of our 35 Portfolio Hand Painted Finishes
 - Mix & Match finishes and materials for the ultimate customized style, or use to adapt your 1 3/8" Heritage Classics Finial to work with R-TEC Automation® Metal Traverse on pages 60 - 67 and Baton Draw Metal Traverse on pages 90 - 97



- 1 3/8" Transitional Cuff / Finial Adapter**
PO138CUFF
3/4" L x 1 1/2" W
Metal, Antique Gold Leaf



Lane Finial with Transitional Cuff in Antique Gold Leaf finish

Style Meets Function

1 3/8" Heritage Classics Finials work with 1 3/8" Metal Traverse using the Finial Adapter. See pages 90 - 97.



Harper Finial with Transitional Cuff in Shimmer finish

Finish »
Antique
Gold Leaf



1 3/8" Metal Brackets



Winston Single
PO138WSSBK
3/4" W x 3 3/4" H backplate, 3 1/2" return
Metal, Luminous



Winston 6" Single
PO138WSS6BK
3/4" W x 3 3/4" H backplate, 6" return
Metal, Luminous



Winston Double
PO138WSDBK
3/4" W x 3 3/4" H backplate, 6" front return
and 3" back return
Metal, Luminous



Gregory Single
PO138GRSBK
3/4" W x 3 3/4" H backplate,
3 1/2" return, use with
Medium C-Rings
Metal, Luminous



Gregory 6" Single
PO138GRS6BK
3/4" W x 3 3/4" H backplate,
6" return, use with Medium
C-Rings
Metal, Luminous



Gregory Double
PO138GRDBK
3/4" W x 3 3/4" H backplate,
6" front return and 3" back return,
use with Medium C-Rings
Metal, Luminous



new **Gregory Horizontal
Single**
PO138GRSHBK
2 3/8" W x 3/4" H backplate,
3 1/2" return, use with
Medium C-Rings
Metal, Luminous



new **Adjustable Single Bracket**
POBKT138
1" W x 3 3/4" H backplate,
adjustable 3 1/2" - 5" return
Metal, Luminous



Ceiling Single
PO138MCMBK
2 3/4" H, 2" DIA backplate,
2 5/8" drop
Metal, Luminous



Inside Mount
PO138MIBK
1" W x 1 1/4" H x 1 7/8" D,
1/4" thick backplate per bracket
Metal, Luminous

Finish »
Luminous





Brielle

Resin, Antique Gold Leaf

1 3/8" Wood & Resin Brackets



William Single
PO138WISBK

1" W x 3 7/16" H backplate, 3 5/8" return
Resin, Spicewood



Shelburne Single
PO138SHBK

1 3/8" W x 4 1/8" H backplate, 3 1/2" return
Resin, Spicewood



new **Ceiling Single**
PO138WOJCBK

1 3/4" W x 4 1/4" D x 1/2" H backplate,
3 1/4" drop
Wood, Spicewood



William 6 5/8" Single
PO138WIS6BK

1" W x 3 7/16" H backplate, 6 5/8" return
Resin, Spicewood



Grace Single
PO138GRBK

1 3/8" W x 7 3/8" H backplate, 3 5/8" return
Resin, Spicewood



Inside Mount (sold in pairs)
PO138WOIBK

1 3/8" W, 1 13/16" H, 1 13/16" D,
13/16" thick backplate per bracket
Wood, Spicewood



William Double
PO138WIDBK

1" W x 3 7/16" H backplate, 6 1/2" front return
and 3 3/4" back return, both cradles hold
1 3/8" diameter wood poles
Resin, Spicewood

Finish »
Spicewood



Portfolio: 1 3/8"

1 3/8" Wood Poles

1 3/8" wood poles are sold in 2' increments. 2' minimum. Poles will be cut to specified lengths; fall off will not be saved or shipped. Maximum continuous length up to 16'.

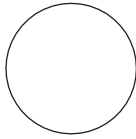

Smooth Wood Pole
PO138SM
Wood, Amulet

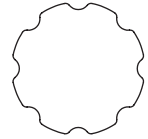

new **Grooved / Fluted Wood Pole**
PO138GR
Wood, Amulet

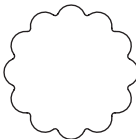

Reeded Wood Pole
PO138RE
Wood, Amulet

Style Meets Function



- Motorized Traverse**
- **RECO** AUTOMATION* 68
 - Somfy® 78
- Manual Traverse**
- HD Corded or Baton 98

1 3/8" Rings

Ring Drop indicates distance from bottom of pole to bottom of ring.



Wood Ring
PO138WRI
1 3/4" ID, 2 5/8" OD, 3/4" drop
Wood, Amulet



Metal Ring
PO138MRI
1 3/4" ID, 2 1/4" OD, 5/8" drop
Metal, Amulet



Medium C-Ring
PO138MCRI
2" ID, 2 3/8" OD, 3/4" drop,
use with Gregory brackets.
Metal, Amulet

1 3/8" Accessories



new **Fiberglass Batons**
36" PORE36WAND
48" PORE48WAND
60" PORE60WAND
3/8" DIA, Fiberglass, Amulet



Clear Acrylic Batons
36" AC36WAND
48" AC48WAND
60" AC60WAND
1/2" DIA, Acrylic



new **Handicap Clear Acrylic Batons**
48" AC48HWAND
60" AC60HWAND
72" AC72HWAND
4" Loop, ADA Compliant, Acrylic



Hinged Elbow
PO138REL
1 5/8" DIA, 3 7/8" overall length,
2" L each side when bent
Resin, Amulet

Finish »
Amulet



Style
Today's
Traditional



2 ¼" Today's Traditional Finial Collection

Purposefully designed with a minimalist elegance that reflects a modern interpretation of classic style with an uncompromising attention to every detail and material, the Today's Traditional Collection elevates timeless window design. Available in any of our 35 Portfolio Hand Painted Finishes or PTH Perfect Match™.

Explore the Style »



Portfolio: 2 1/4"

2 1/4" Today's Traditional Finial Collection

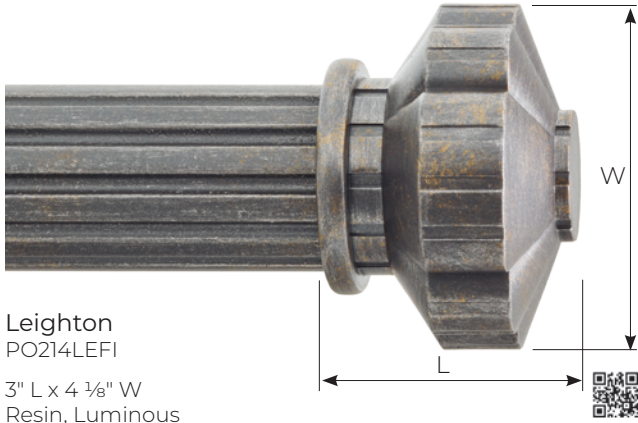

new Leighton
PO214LEFI
3" L x 4 1/8" W
Resin, Luminous



new Leighton - Glass
PO214LEFIGL
3" L x 4 1/8" W
Resin / Glass, Linen

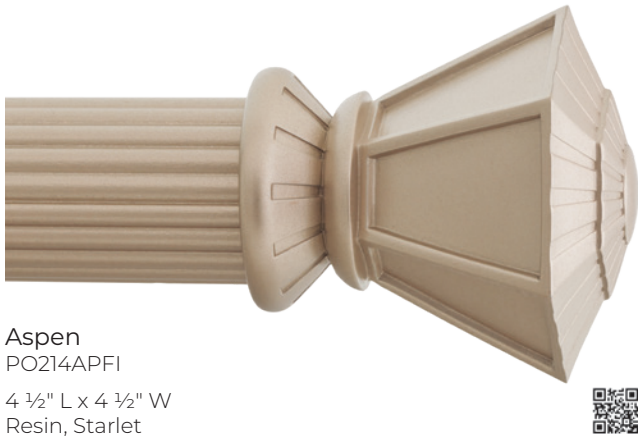

new Aspen
PO214APFI
4 1/2" L x 4 1/2" W
Resin, Starlet



new Aspen - Glass
PO214APFIGL
4 1/2" L x 4 1/2" W
Resin / Glass, Dark Chocolate



new Amelie
PO214AMFI
2" L x 3 1/4" W
Resin, Moonlight



new Amelie - Glass
PO214AMFIGL
2" L x 3 1/4" W
Resin / Glass, Concrete



new Nolan
PO214NOFI
4 5/8" L x 3 1/2" W
Metal / Glass, Mystic

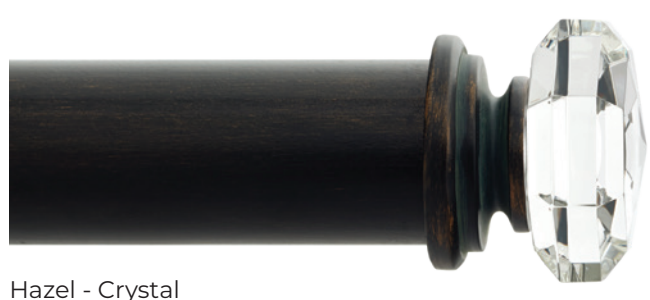

Hazel - Crystal
PO214HZFI
2 5/8" L x 3 3/8" W
Resin / Crystal, Art Bronze



2 1/4" Today's Traditional Finial Collection



Edward
PO214EDFI
4 1/4" L x 3 1/4" W
Resin, Dark Chocolate

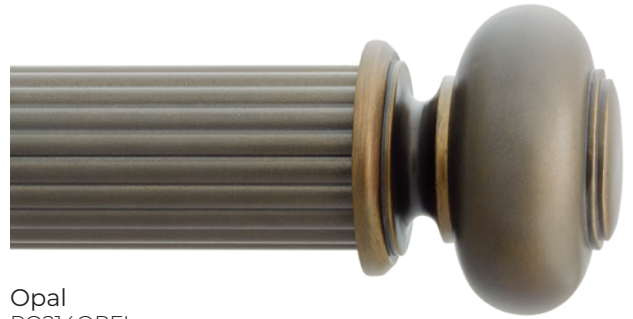

Opal
PO214OPFI
3 1/8" L x 3 3/4" W
Resin, Andiron



Stella
PO214STFI
2 1/2" L x 3 1/4" W
Resin, Starlet



Landon
PO214LNFI
5 1/2" L x 4" W
Resin, Truffle



Sidney
PO214SIFI
3 1/8" L x 4 1/8" W [3" square]
Resin, Amulet



Today's Traditional
Finish Highlight »
Patina & Truffle



Style
Heritage
Classics



2 ¼" Heritage Classics Finial Collection

Our Heritage Classics Style may be a new category, but this collection features new finial designs as well as Paris Texas Hardware classics that have been favorites throughout the years. With ornate details and Old World design, these are sure to make a big statement in your window. Available in any of our 35 Portfolio Hand Painted Finishes or PTH Perfect Match™.

Explore the Style »



2 1/4" Heritage Classics Finial Collection



Large Carved End Cap
PO214LCEC
1 3/8" L x 2 3/4" W
Resin, Mystic



Margot End Cap
PO214MAEC
3/4" L x 3" W
Resin, Antique Gold Leaf



Durham End Cap
PO214DUEC
1" L x 3" W
Resin, Shimmer



new Quentin
PO214QNFI
5" L x 3 1/2" W
Metal / Glass, Amulet



new Farrin - Mercury Glass
PO214FAFI
4 1/2" L x 4 7/8" W
Metal / Glass, Andiron



new Vivian
PO214VVF1
5 1/4" L x 4" W
Metal / Glass, Stardust



Rydal
PO214RYFI
5 3/4" L x 4 1/4" W
Resin, Blush



Lyon
PO214LYFI
4 1/2" L x 4 5/8" W
Resin, Firelight



Portfolio: 2 1/4"

2 1/4" Heritage Classics Finial Collection



Adelaide
PO214ADFI
5" L x 3 1/2" W
Resin, Titanium



Greek
PO214GKFI
5" L x 4 1/4" W
Resin, Antique Gold Leaf



Adelaide - Mercury Glass
PO214ADFIGL
5" L x 3 1/2" W
Resin / Glass, Firelight



Oliver
PO214OLFI
3 5/8" L x 3 7/8" W
Resin, Andiron



Fiona
PO214FIFI
4" L x 5" W
Resin, Amulet



Bordeaux
PO214BOFI
4 5/8" L x 4" W
Resin, Moonlight



Michael
PO214MIFI
6 1/2" L x 4" W
Resin, Antique Gold



Heritage Classics
Finish Highlight »

Andiron &
Antique Gold Leaf



2 1/4" Brackets

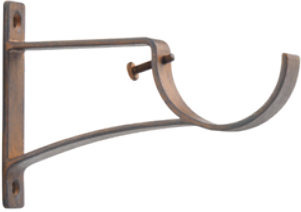

Harlan Single
PO214HASBK
3 3/4" H x 3/4" W backplate, 4" return
Metal, Couture



Harlan 6" Single
PO214HAS6BK
3 3/4" H x 3/4" W backplate, 6" return
Metal, Couture



Harlan Double Bracket
PO214HADBK
3 3/4" H x 3/4" W backplate, 6" front return and 2 1/2" back return, front cradle holds 2 1/4" DIA pole, back cradle holds 1 3/8" DIA pole
Metal, Couture



Adjustable Single Bracket
POBKT214
3 1/2" H x 1" W backplate, adjustable 3 7/8" - 5" return
Metal, Couture



Inside Mount (sold in pairs)
PO214MIBK
1" W x 1 5/8" H x 2 7/8" D, 1/4" thick backplate per bracket
Metal, Couture



Ceiling Single
PO214MCMBK
3 3/4" H x 3 1/4" D, 3 1/2" drop
Metal, Couture

Finish »
Couture



William Single
PO214WISBK
1" W x 3 3/4" H backplate, 4 1/8" return
Resin, Mystic



William 7" Single
PO214WIS6BK
1" W x 3 3/4" H backplate, 7" return
Resin, Mystic



William Double
PO214WIDBK
1" W x 3 3/4" H backplate, 6 3/4" front return and 3 1/4" back return, front cradle holds 2 1/4" DIA pole, back cradle holds 1 3/8" DIA pole
Resin, Mystic



Preston Single
PO214PRBK
1 1/2" W x 4 5/8" H backplate, 4 1/8" return
Resin, Mystic



Ceiling Single
PO214WOJCBK
1 3/4" W x 5 1/2" D x 1/2" H backplate, 4 7/8" drop (distance from ceiling to bottom of pole)
Wood, Mystic

Finish »
Mystic



Portfolio: 2 1/4"

2 1/4" Wood Poles

2 1/4" wood poles are sold in 2' increments. 2' minimum. Poles will be cut to specified lengths; fall off will not be saved or shipped. Maximum continuous length up to 16'.

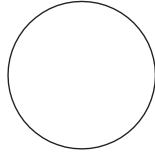

Smooth Wood Pole
PO214SM
Wood, Firelight

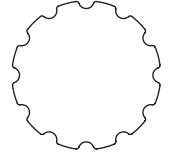

new Grooved / Fluted Wood Pole
PO214GR
Wood, Firelight

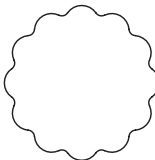

Reeded Wood Pole
PO214RE
Wood, Firelight

Style Meets Function

Motorized Traverse	
• AUTOMATION*	68
• Somfy®	78
Manual Traverse	
• HD Corded or Baton	98

2 1/4" Rings

Ring Drop indicates distance from bottom of pole to bottom of ring.



Wood Ring
PO214WRI
2 5/8" ID, 3 5/8" OD, 7/8" drop
Wood, Firelight



Metal Ring
PO214MRI
2 1/2" ID, 3" OD, 1/2" drop
Metal, Firelight



Forrest Ring
PO214FORI
2 3/4" ID, 3 1/8" OD, 3/4" drop
Metal, Firelight

2 1/4" Accessories



new Fiberglass Batons
36" PORE36WAND
48" PORE48WAND
60" PORE60WAND
3/8" DIA, Fiberglass, Firelight



Clear Acrylic Batons
36" AC36WAND
48" AC48WAND
60" AC60WAND
1/2" DIA, Acrylic



new Handicap Clear Acrylic Batons
48" AC48HWAND
60" AC60HWAND
72" AC72HWAND
4" Loop, ADA Compliant, Acrylic



Hinged Elbow
PO214REL

2 3/8" DIA, 5 1/8" overall length,
2 9/16" L each side when bent
Resin, Firelight

Finish »
Firelight





Designer
Expertise

Elegant and dramatic, large scale finials
provide instant distinction to any window »



Finish »
Stardust



Portfolio: Holdbacks

Modern Holdback Medallions

Fit modern or transitional resin holdback stems; sold separately. Sold in pairs.



Jem
POJEHB
2 ½" DIA, ⅜" TH
Metal, Black



new **Hadley**
POHAHB
3 ½" DIA, 1" TH
Metal, Blush



Mara
POMARHB
3" DIA, ⅞" TH
Metal, Concrete



Blake - Mercury Glass
POBKHB
3" DIA, 2 ⅜" TH
Metal / Glass, Barnwood



new **Parker**
POPAHB
3 ¼" square, 1" TH
Metal, Halo



Achilles
POACHB
2 ½" DIA, ½" TH
Metal, Titanium

Don't forget to
order your
Holdback Stems
separately »

Transitional Holdback Medallions

Fit modern or transitional resin holdback stems; sold separately. Sold in pairs.



Bernadette
POBEHB
4 ½" DIA, 1 ¼" TH
Resin, Silver Maple



Miranda
POMIHB
5" DIA, 1 ½" TH
Resin, Amulet



Isabelle
POISHB
5 ½" DIA, 1 ¼" TH
Resin, Art Bronze



Brooks
POBRHB
4" DIA, 1 ¼" TH
Resin, Firelight



Gloria
POGLHB
5" DIA, 1 ⅜" TH
Resin, Mystic



Mirna
POMRHB
4 ½" DIA, 1 ¼" TH
Resin, Mink



Swindon
POSWHB
5 ⅜" DIA, 1 ¼" TH
Resin, Shimmer



Blois
POBLHB
3 ¾" DIA, ¾" TH
Resin, Urban Bronze



Trudy
POTRHB
4 ¾" DIA, ¾" TH
Resin, Andiron



Chenonceau
POCHHB
3 ¾" DIA, ¾" TH
Resin, Shimmer



Genette
POGEHB
4" DIA, 1 ¼" TH
Resin, New Age Bronze



Lyon
POLYHB
4 ¾" DIA, 2 ½" TH
Resin, Moonlight

Modern Holdback Stems *new*

Must order separately. Sold in pairs.
Projection indicates distance from wall to back of medallion.
Metal, Blush

Base: 2 3/16" DIA, Stem: 1/2" DIA, order 2", 4" or 6" PROJ:

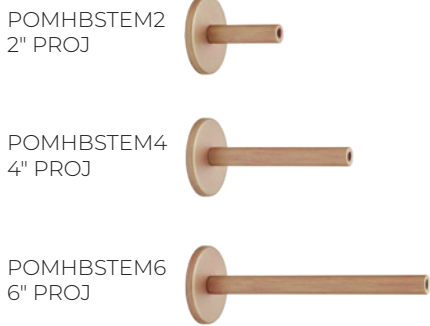

Transitional Holdback Stems *new*

Must order separately. Sold in pairs.
Projection indicates distance from wall to back of medallion.
Resin, Titanium

Base: 3" DIA, Stem: 5/8" DIA, order 2", 4" or 6" PROJ:



Holdback Arms

May be used with any 1 1/8" metal or resin finial without Cuff.
Finials are sold separately.

Holdback Arm
POHBARM

7" W, 1/2" DIA stem
1 5/8" H backplate, 5 1/2" D,
4 1/2" PROJ
Metal, Black



Holdback Arm
shown with Achilles Finial
Metal, Urban Bronze

Holdback Medallion Band

Attaches any Holdback Medallion to the front of a pole. Holdback Medallions sold separately.



1 1/8" Band
PO118MEBAND
3/4" W, 1 3/16" ID, 1 5/16" OD
Metal, Silver Maple



1 3/8" Band
PO138MEBAND
3/4" W, 1 7/16" ID, 1 5/8" OD
Metal, Silver Maple



2 1/4" Band
PO214MEBAND
3/4" W, 2 5/16" ID, 2 1/2" OD
Metal, Silver Maple

Common uses for Medallion Bands:

1. Repeated decorative embellishment along the length of a pole.
2. Hold gathered rod pocket drapery panel in place.
3. Ring stop.

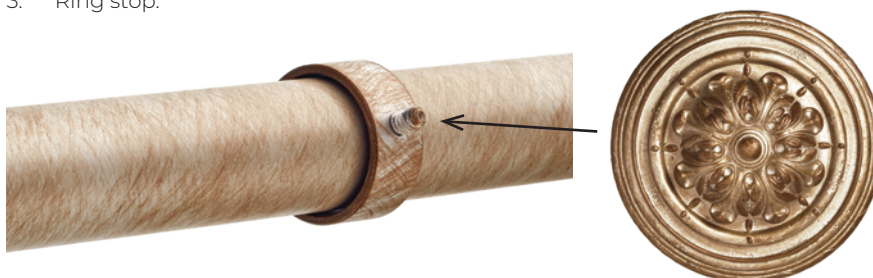



Stardust STA



Manor MA



Truffle TRU



Patina PAT



Bronzed Pewter BP



Greige GRE



Blush BLU



Luminous LU



Couture COU



Concrete CO



Look for our finish highlights throughout the catalog!



Titanium TTM



Urban Bronze URB



Amulet AM



Dark Chocolate DC



Antique Gold AG



Linen LIN



Java JA



Starlet ST



Antique Gold Leaf AGL



Gossamer GOS



New Age Bronze NAB



Firelight FL



Shimmer SH



Silver Maple SM



Andiron AND



Art Bronze AB



Mystic MYS



Halo HA



Mink MK



Moonlight ML



Spicewood SPW



Barnwood BW



Spun Gold SPG



White WH



Black BL

Photography may not accurately represent the true color of a finish. A finish may show slight variation when painted on different materials, such as metal, resin or wood. For best possible finish match, please refer to the actual sample chip.

PTH Perfect Match™

Looking for that *perfect* hardware finish to match your wall, fabric or furniture?

Allow PTH Perfect Match™ to stir your imagination and inspire you to create your own unique window treatment.

Here's How It Works »

Choose any Benjamin Moore® color in either high-gloss or eggshell sheen level.

For a minimal service charge, we will apply your specified color to your Paris Texas Hardware selection and responsibly dispose of any leftover paint.



Make It Your Own »

For a minimal service charge, we will add highlights to your PTH Perfect Match™ hardware selections.

Highlights are only available on PTH Perfect Match™ finishes.

Choose from 4 highlight options »

Silver



Gold



Rose Gold



Glitter



Shown with Silver Highlights »





Traverse Systems

Portfolio Custom Hand Painted Finishes

ships in 10 - 15 business days

All Traverse Systems available in Portfolio Custom Hand Painted Finishes or PTH Perfect Match™.



Stardust STA



Greige GRE



Luminous LU



Truffle TRU



Bronzed Pewter BP



Urban Bronze URB



Patina PAT



Blush BLU



Manor MA



Concrete CO



Couture COU



Amulet AM



Linen LIN



Java JA



Starlet ST



Antique Gold Leaf AGL



Gossamer GOS



Antique Gold AG



New Age Bronze NAB



Firelight FL



Shimmer SH



Silver Maple SM



Andiron AND



Dark Chocolate DC



Art Bronze AB



Mystic MYS



Halo HA



Mink MK

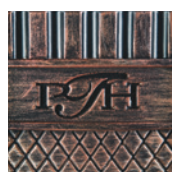

Moonlight ML



Titanium TTM



Spicewood SPW



Barnwood BW



Spun Gold SPG



White WH



Black BL

Quick Ship Metal Finishes

1 3/8" R-TEC Motorized, 1 1/8" Baton Draw and 1 3/8" Baton Draw Metal Traverse Systems

ships in 10 - 15 business days



Brushed Nickel BN



Satin Gold SG



Rose Gold RGD



Brushed Bronze BZ



Charcoal Zinc CZ



Matte Black MK

Quick Ship Wood & Resin Finishes

1 3/8" R-TEC Motorized Metal, R-TEC Motorized, Somfy Motorized, 1 3/8" Baton Draw Metal and Corded/Baton Draw Heavy Duty Traverse Systems

ships in 10 - 15 business days



Platinum PL



Rose Gold RG



Antique Brass AB



Walnut WAL



Oil Rubbed Bronze
ORB

PTH Perfect Match™

» thousands of Benjamin Moore® colors, see page 54

All Traverse Systems available in PTH Perfect Match™.



Motorized and Manual Systems, featuring the new **R·TEC** AUTOMATION® Collection Traverse Systems with our Slim Drapery Motor.

*Motor shown to display Slim feature.

Designed to install seamlessly behind the drapery panel, providing the ultimate integrated functionality without compromising the look of your window treatment.



For your convenience, you can unfold the back cover to view our 35 hand painted Portfolio finishes as you browse.

Finish »
Andiron

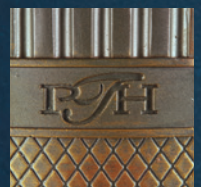



Designer
Expertise

Love the look of flat panels? Consider Ripplefold drapery panels which hold channels of fabric from pole to the floor due to the carriers within the drapery track system »

R-TEC Smart Controls

The R-TEC Automation® Hub and App integration allow draperies to be controlled directly from a smartphone or integrated device while at home or away.



Download on the
App Store



GET IT ON
Google Play

As an alternative, remotes and wall switches allow for individual, group and all control for a customized solution with 1, 5 and 15 channel options.

Finish »
Andiron



We've Got You Covered.

Unrivaled Design »

R-TEC Automation® products are meticulously designed to combine beauty, form and function with superior performance.

Uncompromising Quality & Service »

Our products have been designed and tested to meet the highest industry standards. We proudly stand behind our products by providing expert services to support you along with products backed by a 5 year warranty to protect your client's investment.

Intuitive Programming »

R-TEC Smart Controls offer modern design and lifestyle options with easy programming and the ability to integrate with the latest smart home solutions. The R-TEC Automation® Hub and App solution is designed to control window treatments directly from a smartphone or mobile device and is easily integrated with voice control systems for a more personalized experience.

Unsurpassed Value »

Provide your clients with innovative window treatment solutions that fit their budget expectations with R-TEC Automation® systems that offer unrivaled design, uncompromising quality and service, and intuitive control options at exceptional price points.

For more R-TEC Automation® window solution options, visit the Rowley Company website to view our compatible shade systems at:

bit.ly/R-TEC-Automation-Shades





Finish »
Andiron



RTEC AUTOMATION® 1 3/8" Motorized Metal Traverse new

Motorized 1 3/8" Metal Traverse creates smart designs for both residential and commercial environments. Center or one-way draw, Pinch Pleat or Ripplefold and 5 System Styles. Select from 35 Portfolio Hand Painted Finishes (**except Antique Gold Leaf**), PTH Perfect Match™, 6 Quick Ship Metal Finishes or 5 Quick Ship Wood & Resin Finishes. Coordinates best with our NEW 1 3/8" Modern Metal Collection Finials, but 1 3/8" Today's Traditional Collection Finials and Heritage Classics Collection Finials require the Transitional Cuff / Finial Adapter (sold separately) to work with Metal Traverse.

1 3/8" Motorized Metal Traverse | System Styles new

Traverse Systems include track(s), brackets, motor(s), power option(s), drive belt & clips, pulleys, pendants, master carriers, glides, Ainsley end caps and Push5 channel handheld remote with wall mount. Finials, transitional cuffs / finial adapters and alternative remote options sold separately. See Retail Price List for more system details.

Available colors for components

White

Bronze



Single Traverse System Wall Mount

Wall Bracket is available in 3 1/2" or 6" return options.



Double Traverse System Wall Mount

Wall Bracket is available in 3" and 7 1/2" returns.



Single Traverse System Ceiling Mount

Ceiling Bracket is available in 3 11/16" drop.



Double Traverse System Ceiling Mount

Ceiling Bracket is available in 4" drop with 4 1/2" between centers of tracks.



Single Traverse System Low-Profile Ceiling Mount

Ceiling Bracket is available in 1 1/2" drop.

1 3/8" Motorized Metal Traverse | Overview new

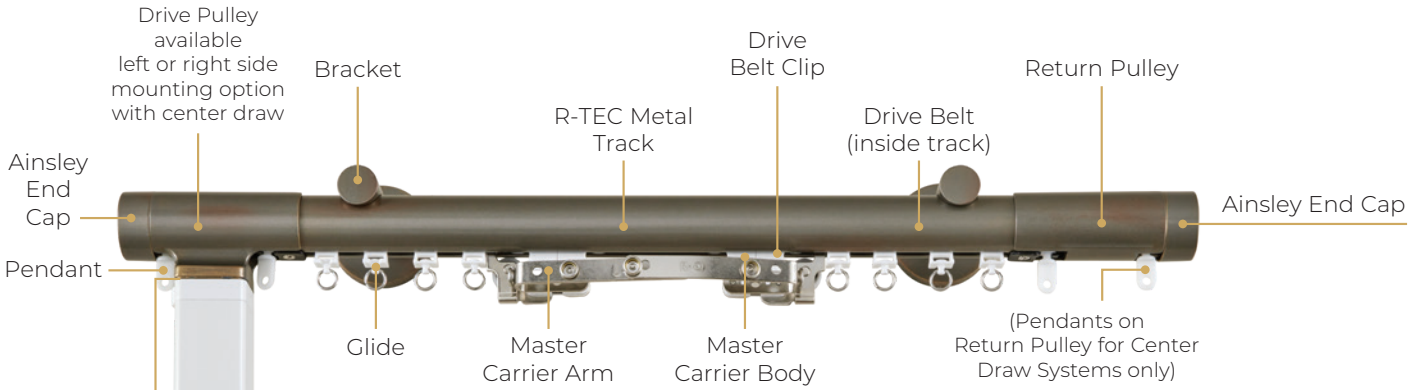

Included in System: R-TEC Automation® Metal Traverse Track(s), Metal End Caps, Brackets, Components, Motor(s), Power Option(s) & Push5 Handheld Remote with Wall Mount



R-TEC Automation® Push5 Handheld Remote with Wall Mount RTMHR5C

- 5 Channel Remote with simple buttons.
- 4 3/4" H x 2" W x 3/8" D
- 1 Remote Control per system
- Range: 65'
- Programmable Favorite Position to set your favorite drapery position
- Off-White

R-TEC Automation® Slim Drapery Motor

- Slim Drapery Motor, 1 per track
- Maximum drapery weight: 77 lbs
- Maximum track length: 24'
- Power Option: Li-ion Battery (includes Battery Charger & USB Cable) or 110v AC/DC Power Transformer (includes 10' Cord with 3 Conductor Male Plug)
- Motor can be mounted on right or left for Center Draw
- Return Hooks/Snaps included; available in white or bronze /BR
- White
- 5 Year Warranty

R-TEC Metal Traverse Track

- Track sold in 1 foot increments, 4' minimum
- Maximum continuous length is 12' on select finishes (see below bullets); spliced lengths up to 24' (maximum of 2 splices per metal traverse track system)
- Maximum continuous length is 12' on 35 Portfolio Finishes (**except Antique Gold Leaf**), BN and MK Quick Ship Metal Finishes, 5 Quick Ship Wood & Resin Finishes and PTH Perfect Match™
- Maximum continuous length is 8' on SG, RGD, BZ and CZ Quick Ship Metal Finishes

Slim Drapery Motor (cannot be top mounted)

Li-ion Battery shown (110v AC/DC Power Transformer option available)

Motor & Power Options

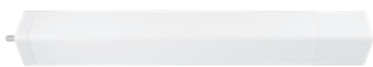

Slim Drapery Motor RTMLDSS50



Li-ion Battery RTMLDSSB



Battery Charger RTMLDSSBC



USB Charger Cable RTMLDSSUSB



110v AC/DC Power Transformer 10' (plug included) RTMDSSPT

Features



2-Way RF Communication

Integrated radio frequency control allows for easy programming of individual, group or all control across window treatments.



Adjustable Speed

Choose from three options to customize the open / close speed of the drapery treatment.

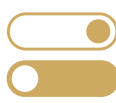

Preferred Open / Close Limit Settings

Electronic "autose" limits accurately program preferred open and close limit settings.



Favorite Position

Allows a most used or favorite position to be set between open and close limit settings.



Obstruction Detection

If the drapery motion is obstructed while the motor is running, the motor stops automatically to prevent damage.



Manual Override

Permits the drapery to be adjusted manually without the use of a remote or in the event of a power outage.



Quiet Operation

Powerful, smooth and quiet operation suitable for both residential & commercial environments.



R-TEC Automation® | R-TEC Smart Controls new

- R-TEC Automation® is a convenient, comfortable, lifestyle solution that integrates smart technology solutions allowing you to control a variety of window treatments throughout the home.
- Easily connect your automated drapery to voice control systems using our R-TEC Hub, taking drapery control to the next level.



Handheld Remote with Wall Mount
RTMHR1C
1 Channel Remote gives you control from a sleek handheld device.
Range: 65' | White



Push5 Handheld Remote with Wall Mount (included in systems)
RTMHR5C
5 Channel Remote with simple buttons.
Range: 65' | Off-White



Handheld Remote with Wall Mount
RTMHR15C
15 Channel Remote gives you control with modern LCD display.
Range: 65' | White



ARC™ USB Signal Repeater
RTMUSR
USB Signal Repeater extends the wireless range of the R-TEC Hub or Remotes up to 60'.
Max. 2 repeaters per system or network.
White; color may vary.



Surface Mount Wall Switch
RTMWSR5C
5 Channel Surface Switch with slim design and flush mount configuration for easy installation.
Range: 65' | White



R-TEC Hub
RTMHUB2
With Wi-Fi built in and 2-Way RF, simply plug in where convenient and connect to the local network | Range: 60' | White



Push15 Handheld Remote with Wall Mount
RTMHRP15C RTMHRP15C/K
15 Channel Remote with simple buttons.
Range: 65' | White or Black/K



Interior Sun Sensor
RTMISS
Sun Sensor automatically manages daylight transitions at each window.
Range: 65' | White



Wall Charger for USB Signal Repeater
RTMLWCW
Simply plug in the ARC USB Signal Repeater to the wall charger for easy install.
White; color may vary.



Wall Box Mount Switch
RTMWSR15C
15 Channel Box Switch mounts into a standard electric switch box. Cut in mount configuration creates a seamless look.
Range: 65' | White



R-TEC Automation® App

Our App enables simple, intuitive control and system configuration from your smartphone or tablet. Available on the Apple® App Store or Google Play™.



Pair the R-TEC Automation® App and Hub with these systems (sold separately) »



R-TEC Hub RTMHUB2

With Wi-Fi built in and 2-Way RF, simply plug in where convenient and connect to the local network | Range: 60' | White

1 3/8" Motorized Metal Traverse | Brackets & Accessories new

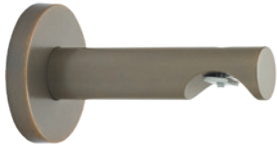

new Wall Mount Single
PTHMT138400
2 7/16" DIA backplate, 3 1/2" return
Metal, Andiron



new Wall Mount 6" Single
PTHMT138401
2 7/16" DIA backplate, 6" return
Metal, Andiron



new Wall Mount Double
PTHMT138402
2 7/16" DIA backplate, 7 1/2" front return and
3" back return
Metal, Andiron



Finish »
Andiron



new Ceiling Mount Single
PTHMT138403
1 7/8" DIA backplate, 3 11/16" drop
Metal, Andiron



new Ceiling Mount Double
PTHMT138404
4 1/2" between centers of tracks,
1 7/8" DIA backplate, 4" drop
Metal, Andiron

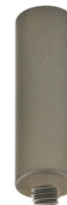

new Ceiling Bracket Extender
PTHMT138405
2" drop
Metal, Andiron



new Low-Profile
Ceiling Single
PTHMT138406
1 3/4" L x 3/4" W, 1 1/2" drop
Metal, Andiron



new Connector / Splice
PTHMT138407

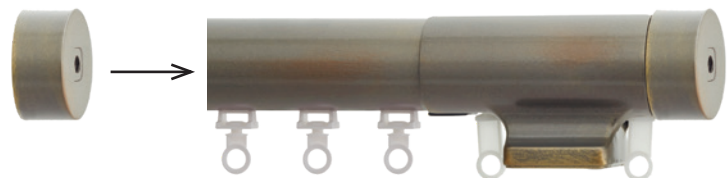

new 1 3/8" Transitional Cuff / Finial Adapter
PO138CUFF QS138CUFF
3/4" L x 1 1/2" W
• Metal, Available in any of our 35 Portfolio Hand Painted Finishes,
5 Quick Ship Wood & Resin Finishes or PTH Perfect Match™
• Required to adapt your 1 3/8" Today's Traditional or Heritage Classics
Finials to work with Metal Traverse, sold separately

See Retail Price List for more traverse system details, including diagrams & specifications for brackets.

1 3/8" Motorized Metal Traverse | Carriers new

Master Carrier Body, available in white or bronze /BR, is required for each master carrier arm - sold separately.



Master Carrier Body
RTPTH138MCB
RTPTH138MCB/BR

Select from different arms to assemble into one MC Body; order two if ordering Center Draw MC Arms - sold separately. Pinch pleat or Ripplefold. Available in white or bronze /BR.



Overlap MC Arms for Center Draw
RTPTH138CD

Tandem MC Arms for Center Draw
RTMDTCDTAN

Pair. Pinch pleat or Ripplefold; order two MC Bodies - sold separately. Available in Stainless Steel only.



MC Arm for One-Way Draw
RTPTH138PPOR
RTPTH138PPOL

Right (R) or Left (L). Pinch pleat or Ripplefold; order one MC Body - sold separately. Available in Stainless Steel only.



Ripplefold Butt MC Arms for Center Draw
RTMDTCDB

Pair. Ripplefold only; order two MC Bodies - sold separately. Do not overlap, allowing some light to filter between draperies on center draw treatments Available in Stainless Steel only.



Ripplefold Butt MC Arm for One-Way Draw
RTPTH138OBR
RTPTH138OBL

Right and left use. Ripplefold only; order one MC Body - sold separately. Available in Stainless Steel only.

Glides are available for standard Pinch Pleat or Ripplefold® Style treatments. For more details on pinch pleat and Ripplefold glides, please see the price list.



Pinch Pleat Glides
CP40 CP40/BR

Wheel for smooth movement. Available in white or bronze /BR.



Ripplefold® Style Glides

- R4060 R4060/BR 60% fullness
- R4080 R4080/BR 80% fullness
- R4100 R4100/BR 100% fullness
- R4120 R4120/BR 120% fullness

Ripplefold Glides with detachable pendants. Available in white or bronze /BR.

See Retail Price List for more traverse system details, including diagrams & specifications for brackets.

Style Meets Function



Adele

Resin / Glass, Andiron

Upgrade your End Cap with Finial Styles

new 1 3/8" Transitional Cuff / Finial Adapter

PO138CUFF QSI38CUFF
3/4" L x 1 1/2" W

- Metal, Available in any of our 35 Portfolio Hand Painted Finishes, 5 Quick Ship Wood & Resin Finishes or PTH Perfect Match™
- Required to adapt your 1 3/8" Today's Traditional or Heritage Classics Finials to work with Metal Traverse, sold separately



Transitional Cuff in Andiron finish on 1 3/8" R-TEC Automation® Metal Traverse

Style Meets Function

1 3/8" Today's Traditional and Heritage Classics Finials require the Transitional Cuff / Finial Adapter.



Lillian Finial with Transitional Cuff in Andiron finish

1 3/8" Motorized Metal Traverse | Finials new

1 3/8" R-TEC Motorized Metal Traverse Systems include End Caps, but are designed to work with all 1 3/8" Finials across three style categories. Today's Traditional and Heritage Classics Finials require the use of the Transitional Cuff / Finial Adapter to work with Metal Traverse. Modern Finials do not require the use of the Finial Adapter.



Portfolio pages 28 - 29 | Quick Ship pages 116 - 117 | *Transitional Cuff / Finial Adapter PO138CUFF not required



Portfolio pages 34 - 35 | Quick Ship pages 122 - 123 | *Requires Transitional Cuff / Finial Adapter PO138CUFF or QS138CUFF



Portfolio pages 36 - 37 | Quick Ship pages 124 - 125 | *Requires Transitional Cuff / Finial Adapter PO138CUFF or QS138CUFF

How To Add Your Transitional Cuff / Finial Adapter »

- 1 Select your Cuff style and finish - Mix & Match for the ultimate customization.
- 2 Place Cuff onto metal traverse and tighten set screw with Allen Wrench.
- 3 Install finials by screwing into the Cuff / Finial Adapter.



Finish »
Antique
Gold Leaf



R-TEC AUTOMATIC[®] by Rowley

R-TEC Motorized Heavy Duty Traverse new

Create a commercial look with the benefits of motorization using our NEW R-TEC Automation[®] Track. Center or one-way draw, Pinch Pleat or Ripplefold and 4 System Styles. Decorative wood fascia available in 1 3/8" or 2 1/4" smooth, reeded or grooved / fluted profiles with coordinating finials, 1 7/8" slim round smooth profile, 2 1/4" flat smooth profile with flush ends or mitered returns. Select from 35 Portfolio Hand Painted Finishes, PTH Perfect Match[™] or 5 Quick Ship Wood and Resin Finishes.

R-TEC Motorized Heavy Duty Traverse | System Styles new

Traverse Systems include track(s), brackets, motor(s), power option(s), drive belt & clips, pulleys, master carriers, glides and 5 channel handheld remote with wall mount. See below descriptions for more details. All traverse systems are available with or without decorative wood fascia. Finials are sold separately. 1 3/8" or 2 1/4" Portfolio and Quick Ship Wood and Resin Finials are compatible. Not available for use with rings. See Retail Price List for more traverse system details.

Available colors for R-TEC track, brackets and components

White

Bronze



Single Traverse System
Wall or Ceiling Mount

Traverse Systems include track, brackets and glides. Wood fascia option available.



Double Traverse System
Wall or Ceiling Mount

Traverse Systems include track, brackets and glides. Wood fascia options available for front and back.



Single or Double Traverse System with Mitered Returns

Traverse Systems include track, brackets and glides. Wood fascia options available for front and back. Mitered returns sold separately.



Double Traverse System with Back Traverse & Stationary Pole in Front

Traverse Systems include track, stationary pole, brackets and glides. Wood fascia for back track available.

R-TEC Motorized Heavy Duty Traverse | Overview new

Finial, End Cap or Mitered Return

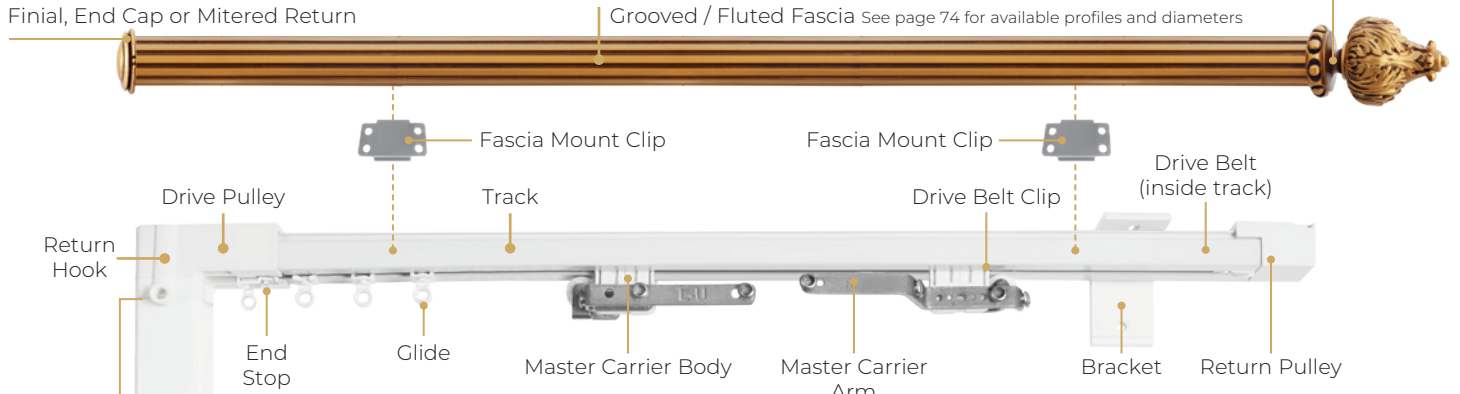

Included in System: R-TEC Automation® Track(s), Fascia(s), Brackets, Components, Motor(s), Power Option(s) & Push5 Handheld Remote with Wall Mount

System requirements:
1 Drive Pulley & 1 Return Pulley for One-Way Draw;
2 Drive Pulleys for Center Draw

R-TEC Automation® Slim Drapery Motor

- Slim Drapery Motor, 1 per track
- Maximum drapery weight: 110 lbs
- Maximum track length: 36'
- Power Option: Li-ion Battery (includes Battery Charger & USB Cable) or 110v AC/DC Power Transformer (includes 10' Cord with 3 Conductor Male Plug)
- Motor can be mounted on right or left for Center Draw, or top mounted
- Return Hooks/Snaps included; available in white or bronze /BR
- White
- 5 Year Warranty

R-TEC Automation® Track

- Track sold in 1 foot increments, 4' minimum
- Maximum continuous length is 19'; spliced lengths up to 36'
- Available in white or bronze /BR
- May be ordered with or without Fascia
- Fascia options shown on page 74

*Tandem alternative option: see page 21 of the Drapery Databook for details.



R-TEC Automation® Push5 Handheld Remote with Wall Mount RTMHR5C

- 5 Channel Remote with simple buttons.
- 4 3/4" H x 2" W x 3/8" D
- 1 Remote Control per system
- Range: 65'
- Programmable Favorite Position to set your favorite drapery position
- Off-White

Slim Drapery Motor* (can be top mounted)

Li-ion Battery shown (110v AC/DC Power Transformer option available)

Motor & Power Options



Slim Drapery Motor RTMLDSS50



Li-ion Battery RTMLDSSB



Battery Charger RTMLDSSBC



USB Charger Cable RTMLDSSUSB



110v AC/DC Power Transformer 10' (plug included) RTMDSSPT

Features



2-Way RF Communication

Integrated radio frequency control allows for easy programming of individual, group or all control across window treatments.



Adjustable Speed

Choose from three options to customize the open / close speed of the drapery treatment.

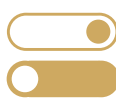

Preferred Open / Close Limit Settings

Electronic "autoset" limits accurately program preferred open and close limit settings.



Favorite Position

Allows a most used or favorite position to be set between open and close limit settings.



Obstruction Detection

If the drapery motion is obstructed while the motor is running, the motor stops automatically to prevent damage.



Manual Override

Permits the drapery to be adjusted manually without the use of a remote or in the event of a power outage.



Quiet Operation

Powerful, smooth and quiet operation suitable for both residential & commercial environments.



R-TEC Automation® | R-TEC Smart Controls new

- R-TEC Automation® is a convenient, comfortable, lifestyle solution that integrates smart technology solutions allowing you to control a variety of window treatments throughout the home.
- Easily connect your automated drapery to voice control systems using our R-TEC Hub, taking drapery control to the next level.



Handheld Remote with Wall Mount
RTMHR1C
1 Channel Remote gives you control from a sleek handheld device.
Range: 65' | White



R-TEC Hub
RTMHUB2
With Wi-Fi built in and 2-Way RF, simply plug in where convenient and connect to the local network | Range: 60' | White



Push5 Handheld Remote with Wall Mount (included in systems)
RTMHRP5C
5 Channel Remote with simple buttons.
Range: 65' | Off-White



Push15 Handheld Remote with Wall Mount
RTMHRP15C RTMHRP15C/K
15 Channel Remote with simple buttons.
Range: 65' | White or Black/K



Handheld Remote with Wall Mount
RTMHR15C
15 Channel Remote gives you control with modern LCD display.
Range: 65' | White



Interior Sun Sensor
RTMISS
Sun Sensor automatically manages daylight transitions at each window.
Range: 65' | White



ARC™ USB Signal Repeater
RTMUSR
USB Signal Repeater extends the wireless range of the R-TEC Hub or Remotes up to 60'.
Max. 2 repeaters per system or network.
White; color may vary.



Wall Charger for USB Signal Repeater
RTMLWCW
Simply plug in the ARC USB Signal Repeater to the wall charger for easy install.
White; color may vary.



Surface Mount Wall Switch
RTMWSR5C
5 Channel Surface Switch with slim design and flush mount configuration for easy installation.
Range: 65' | White



Wall Box Mount Switch
RTMWSR15C
15 Channel Box Switch mounts into a standard electric switch box. Cut in mount configuration creates a seamless look.
Range: 65' | White



R-TEC Automation® App

Our App enables simple, intuitive control and system configuration from your smartphone or tablet. Available on the Apple® App Store or Google Play™.



Pair the R-TEC Automation® App and Hub with these systems (sold separately) »



R-TEC Hub RTMHUB2

With Wi-Fi built in and 2-Way RF, simply plug in where convenient and connect to the local network | Range: 60' | White



R-TEC Motorized Heavy Duty Traverse | Brackets new

Easy click installation. Components are white; to order components in bronze, add /BR.



R-TEC Single
TB035-R

2 1/16" H x 1 1/2" W backplate,
adjustable up to 3 3/4" return
Available in white or bronze /BR.



R-TEC Single or Double
TB060-R

3 5/16" H x 1 1/2" W backplate,
5 1/4" front return and 2" back return
Available in white or bronze /BR.



R-TEC Single, Double or Triple
TB100-R

4 1/2" H x 1 1/2" W backplate,
adjustable up to 9" return
Available in white or bronze /BR.



Fascia Mount Clip
RTMDTFC

1/2" H x 1" W
Use to attach fascia to
traverse systems; included.
Available in zinc.



Ceiling Mount Clip Single
RTMDTBCM

1/4" H x 2 3/4" D x 1 1/16" W
May only be used in systems without fascia.
*For double ceiling mount installation,
install two brackets into ceiling.*
Available in white.



Drapery Return Bracket
CP500

9/16" H x 1/2" W backplate, 1 3/4" return
Allows for return on track hardware in
traverse systems; included.
Available in zinc only.



Custom Over-Bracket Single
TBKT214-R

3 1/2" H x 3/4" W backplate, 7 7/8" front return and 3" back return
Use to combine 2 1/4" full wood pole with single traverse systems;
includes traverse ceiling mount bracket attached onto the bottom
of the over-bracket. Fascias sold separately. Available in any of our
35 hand painted Portfolio finishes, 5 Quick Ship Wood & Resin
finishes or your own custom PTH Perfect Match™ finish.
Steel, Antique Gold Leaf



Custom Ceiling Single
CMTB-R

2 3/4" H x 3/4" W backplate
Specify drop: contingent upon which fascia or finials
are chosen - *for double ceiling mount installation,
install two brackets into ceiling.*
Steel, Antique Gold Leaf

See Retail Price List for more traverse system details, including diagrams & specifications for brackets.



Finish »
Antique
Gold Leaf



R-TEC Motorized Heavy Duty Traverse | Carriers new

Master Carrier Body, available in white or bronze /BR, is required for each master carrier arm - sold separately.



Master Carrier Body
RTMDTMCB
RTMDTMCB/BR

Select from different arms to assemble into one MC Body; order two if ordering Center Draw MC Arms - sold separately. Pinch pleat or Ripplefold. Available in white or bronze /BR.



Overlap MC Arms for Center Draw
RTMDTCD

Tandem MC Arms for Center Draw
RTMDTCDTAN

Pair. Pinch pleat or Ripplefold; order two MC Bodies - sold separately. Available in Stainless Steel only.



MC Arm for One-Way Draw
RTMDTOR
RTMDTOL

Right (R) or Left (L). Pinch pleat or Ripplefold; order one MC Body - sold separately. Available in Stainless Steel only.



Ripplefold Butt MC Arms for Center Draw
RTMDTCDB

Pair. Ripplefold only; order two MC Bodies - sold separately. Do not overlap, allowing some light to filter between draperies on center draw treatments Available in Stainless Steel only.



Ripplefold Butt MC Arm for One-Way Draw
RTMDTOB

Right and left use. Ripplefold only; order one MC Body - sold separately. Available in Stainless Steel only.

Glides are available for standard Pinch Pleat or Ripplefold® Style treatments. For more details on pinch pleat and Ripplefold glides, please see the price list.



Pinch Pleat Glides
CP40 CP40/BR

Wheel for smooth movement. Available in white or bronze /BR.



Ripplefold® Style Glides

R4060	R4060/BR	60% fullness
R4080	R4080/BR	80% fullness
R4100	R4100/BR	100% fullness
R4120	R4120/BR	120% fullness

Ripplefold Glides with detachable pendants. Available in white or bronze /BR.

See Retail Price List for more traverse system details, including diagrams & specifications for brackets.

Motorized Heavy Duty Traverse | Fascia Profiles



Smooth

- 1 3/8" and 2 1/4" diameters available
- See next page for coordinating finial options

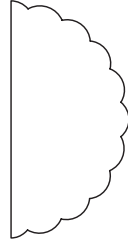

Reeded

- 1 3/8" and 2 1/4" diameters available
- See next page for coordinating finial options



Grooved / Fluted

- 1 3/8" and 2 1/4" diameters available
- See next page for coordinating finial options



Slim Round Smooth, No Finials

- 1 7/8" diameter, available with flush ends or mitered returns



Flat Smooth, No Finials

- 2 1/4" height, available with flush ends or mitered returns



**Mitered Returns
(sold separately)**

- 1 3/8", 1 7/8" and 2 1/4" diameters available
- All profiles



For a more finished look or the perfect solution for covering bay or corner windows, add mitered returns to your fascia »

R-TEC Motorized Heavy Duty Traverse | Finials *new*

Finials are sold separately. 1 3/8" or 2 1/4" Portfolio and Quick Ship Wood and Resin finials are compatible across two style categories.



1 3/8" Portfolio pages 34 - 35 | 1 3/8" Quick Ship pages 122 - 123 | 2 1/4" Portfolio pages 41 - 43 | 2 1/4" Quick Ship pages 130 - 131



1 3/8" Portfolio pages 36 - 37 | 1 3/8" Quick Ship pages 124 - 125 | 2 1/4" Portfolio pages 44 - 46 | 2 1/4" Quick Ship pages 132 - 133

Endless *Finishes*

35 Portfolio Hand Painted Finishes »

We've expanded our popular Portfolio finish assortment to include 10 new design-inspired finishes for a total of 35 sophisticated finishes hand painted by our own talented artisans.

RTH Perfect Match™ »

Our talented artisans also enjoy creating the perfect match to any finish that you can envision. Select from any Benjamin Moore® paint color and we'll apply it to your sheen specification with the option to add highlights to fully customize the finish.

5 Quick Ship Wood & Resin Finishes »

Select from our Tried and True Quick Ship Wood & Resin finishes. Available in Platinum (PL), Walnut (WAL), Rose Gold (RG), Antique Brass (AB) and Oil Rubbed Bronze (ORB). See pages 130 - 133 for available finial styles.

R-TEC AUTOMATION® by Rowley®

THE DIFFERENCE IS IN THE DETAILS

The sophistication is reflected in the simple form & sleek lines »



Aesthetic »

- Easy to conceal behind drapery fabric.
- Electronic limit allows accurate preferred open and close limit settings.
- Favorite position allows one additional position between open and close limit settings.
- Motor starts and stops slowly and gently, maintaining the aesthetic of your drapery treatment.



Flexible »

- Light touch start/stop function: Pulling the drapery gently triggers motor to run automatically.
- Versatile master carrier reduces friction & is adaptable to various drapery types.
- Adjustable drapery speed control.
- Compatible with R-TEC Smart Controls on page 71.



Efficient »

- Manual override permits the drapery to be adjusted manually, making it ideal for power outages.
- Obstruction detection: If the drapery motion is obstructed while motor is running, the drapery motor stops automatically to prevent any damage.

Finish »
**Antique
Gold Leaf**



R-TEC Automation® Provide your clients with innovative window treatment solutions that fit their budget expectations with R-TEC Automation® systems that offer unrivaled design, uncompromising quality and service, and intuitive control options at exceptional price points.



Featuring our NEW R-TEC Automation® Slim Drapery Motor

Motorized Traverse Systems | R-TEC Automation® or Somfy Motors

R-TEC AUTOMATION® by Rowley

R-TEC Automation® System Features:

- Max. Drapery Weight: 110 lbs. Slim Motor
- Track sold in 1 foot increments, 4' minimum
- Maximum continuous length is 19'
- Spliced lengths up to 36' with Slim Drapery Motor
- 5 Channel Handheld Remote with Wall Mount per system
- Li-ion Battery or 110v AC/DC Power Transformer 10'
- Optional Solar Power Battery Charger
- Programmable Favorite Position
- App R-TEC Automation® available on the Apple® App Store or Google Play™



Pair the R-TEC Hub and App with these systems:

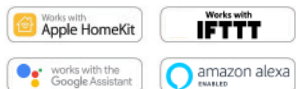

Li-Ion Battery or 110v AC/DC Power Transformer

somfy.

Somfy® System Features:

- Max. Drapery Weight:
 - 99 lbs. Irismo™ 45 Heavy Duty Motor
 - 77 lbs. Irismo™ 35 Mini Motor
 - 132 lbs. Glydea® Ultra 60e RTS Heavy Duty Motor
 - 77 lbs. Glydea® Ultra 35e RTS Standard Motor
- Track sold in 1 foot increments, 6' minimum
- Maximum continuous length is 20'
- Spliced lengths up to 32' with Somfy Motors
- 5-Channel Transmitter per system
- Standard 10' Cord; transformer is housed within the Glydea® Ultra Drapery Motors
- Programmable "My" Position
- Curved tracks available with minimum 11.8" Radius; curving fees apply
- App TaHoma® available on the Apple® App Store or Google Play™

Pair the TaHoma® App with these systems:





Finish »
Art Bronze



Somfy® Motorized Heavy Duty Traverse

Motorized System is perfect for all treatments – from lightweight sheers to heavily lined fabrics, and is the ideal solution for treatments mounted where corded systems are not easily reached. Center or one-way draw, Pinch Pleat or Ripplefold and 4 System Styles. Decorative wood fascia available in 2 ¼" smooth, reeded, grooved / fluted profiles with flush ends or or mitered returns. Select from 35 Portfolio Hand Painted Finishes, PTH Perfect Match™ or 5 Quick Ship Wood and Resin Finishes.

Somfy Motorized Heavy Duty Traverse | System Styles

Traverse Systems include track, brackets, motor, power option, drive belt & clips, pulleys, master carriers, glides and 5 channel remote. See below descriptions for more details. All traverse systems are available with or without decorative wood fascia. Finials are sold separately. 2 1/4" Portfolio and Quick Ship Wood and Resin Finials are compatible. Not available for use with C-Rings. See Retail Price List for more traverse system details.

Available colors for Somfy track, brackets and components

White

Bronze



Single Traverse System Wall or Ceiling Mount

Traverse Systems include track, brackets and glides. Wood fascia option available.



Double Traverse System Wall or Ceiling Mount

Traverse Systems include track, brackets and glides. Wood fascia option available for front and back.



Single or Double Traverse System with Mitered Returns

Traverse Systems include track, brackets and glides. Wood fascia options available for front and back. Mitered returns sold separately.



Double Traverse System with Back Traverse & Stationary Pole in Front

Traverse Systems include track, stationary pole, brackets and glides. Wood fascia for back track available.

Traverse Systems: Motorized 2 1/4"



Somfy Motorized Heavy Duty Traverse | Overview

Somfy motorized track

- Track sold in 1 foot increments, 6' minimum
- Maximum continuous length is 20'; spliced lengths up to 36'
- Includes one motor, standard remote control 5-channel transmitter per track, and fascia with fascia clips when applicable
- Available in white or bronze; track finish will complement fascia finish

- End drive gears available in white or bronze
- May be ordered with or without Paris Texas Hardware™ Fascia options
- Curved Tracks available with minimum 11.8" radius; curving fees apply

Somfy Motorized Heavy Duty Traverse | Motors & Smart Controls

- Compatible with other Somfy motorized products.
- My Position (set your favorite drapery position).
- Individual or multi-system control.
- Manual override and touch control.



new Somfy TaHoma® gateway 1811731

Control your window coverings with a smartphone or tablet.

TaHoma® puts you in control, so you can operate your motorized applications whether you're home or away, using technology that's open and forward-looking.

On vacation and realized you forgot to close your draperies? Not a problem, with a simple tap of a button in the TaHoma® App, you can close all your window treatments at once.

Pair with these systems (sold separately):



Free app for iOS and Android:



new Irismo 45 Standard Drapery Motor

99 lb. maximum drapery weight and rechargeable battery is included. Battery Charger sold separately.



Somfy Situø®/Telis Standard Remote Control Transmitter

5 3/4" H x 1 5/8" W
5 channel. 1 remote control per track. Programmable My Position to set your favorite drapery position. Available in white.



new Irismo 35 Mini Drapery Motor

77 lb. maximum drapery weight and transformer is within the motor housing. DC Power Transformer.



RTS Remote Control Transmitter

6" H x 2" W | Range: 65'
16 channel. Programmable timer and on-screen display. Available with wall mount clip. Available in silver.



Glydea® ULTRA 60e Heavy Duty Drapery Motor

132 lb. maximum drapery weight. AC Power.



Indoor Sun Control

2 3/16" DIA x 3/4" D | Range: 65'
Uses the intensity of the sun to provide automatic control of window coverings in the home. Mounts on window sill or window glass. Available in white.



Glydea® ULTRA 35 Standard Drapery Motor

77 lb. maximum drapery weight. AC Power.

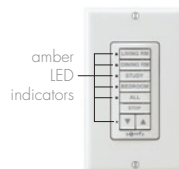

Wireless RTS Wall Switches

4 1/2" H x 2 3/4" W | Range: 65'
1 or 5 channel. Open or close the motorized drapery when you enter or exit a room. Battery powered, wireless switch. Customizable buttons for selecting window treatments throughout the house. Custom button labels available. Available in white.

See Retail Price List for more traverse system details.

Somfy Motorized Heavy Duty Traverse | Brackets



Somfy Single
TB035-S
2 11/16" H x 1 1/2" W backplate, adjustable 2 3/4" - 3 5/8" return
Available in white or bronze /BR and included in Single Systems.



Somfy Single or Double
TB060-S
3 5/16" H x 1 1/2" W backplate, adjustable 5" - 5 3/8" front return and adjustable 1 3/4" - 2 1/2" back return
Available in white or bronze /BR and included in Double Systems. May be substituted for Single Systems when 6" return is needed.



new **Somfy Single, Double or Triple**
TB100-S
4 1/2" H x 1 1/2" W backplate, adjustable up to 9 3/16" return
Available in white or bronze /BR.



Somfy Fascia Clip
SOMFY CLIP
Use to attach fascia to traverse systems; included.



Somfy Ceiling Mount Single
CMBC-S
3/4" H x 1" W x 2" D
May only be used in systems without fascia for Single or Double Systems. Available in white or bronze /BR.



Somfy Ceiling Systems with Fascia Single
CMBC-S
2 3/4" H x 3/4" W backplate
May only be used in systems with fascia for Single or Double Systems. Available in 35 Portfolio, 5 Quick Ship Wood & Resin or PTH Perfect Match™ finishes.
Steel, Art Bronze



Somfy Over-Bracket
TBKT214-S
3 1/2" H x 3/4" W backplate, 7 7/8" front return and 3" back return
Use to combine 2 1/4" full wood pole with Single Traverse Systems. Traverse mounting bracket simply attaches directly into the bottom of the Over-Bracket. Available in 35 Portfolio and PTH Perfect Match™ finishes.
Steel, Art Bronze

Somfy Motorized Heavy Duty Traverse | Carriers

Master Carrier Body, available in white or bronze /BR, is required for each master carrier arm - sold separately.



Master Carrier Body
1781344
Select from different arms to assemble into one MC Body; order two if ordering Center Draw MC Arms - sold separately. Pinch pleat or Ripplefold. Available in gray with white only.



Overlap MC Arms for Center Draw
1782320 (Under Arm)
1782321 (Over Arm)

Tandem MC Arms for Center Draw
1782662 (Under Arm)
1780947 (Overarm)

Pinch pleat or Ripplefold; order two MC Bodies - sold separately. Available in Stainless Steel only.



MC Arm for One-Way Draw
1782321

Right and Left use. Pinch pleat or Ripplefold; order one MC Body - sold separately. Available in Stainless Steel only.



Ripplefold Butt MC Arms for Center Draw
1780953

Tandem Option
1782319

Each, order 2. Ripplefold only; order two MC Bodies - sold separately. Do not overlap, allowing some light to filter between draperies on center draw treatments. Available in Stainless Steel only.



Ripplefold Butt MC Arm for One-Way Draw
1782319

Right and left use. Ripplefold only; order one MC Body - sold separately. Available in Stainless Steel only.

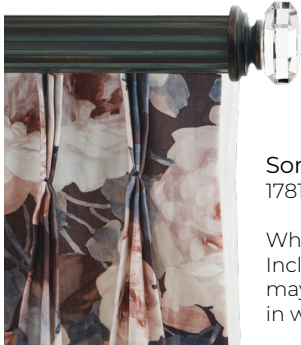

Somfy Standard Pinch Pleat Glide
1781415 white 1782869 bronze

Wheeled for smooth movement. Included in system; additional glides may be ordered separately. Available in white or bronze.



Somfy Ripplefold Glide
1780901 white 1782870 bronze 120% fullness
1780902 white 1782871 bronze 100% fullness
1780903 white 1782872 bronze 80% fullness

Snap accepts Ripplefold tape and swivels to create fold. Fullness 80%, 100% or 120%. Available in white or bronze.

See Retail Price List for more traverse system details.



Finish »
Concrete



1 1/8" Baton Draw Metal Traverse new

The perfect modern solution for residential or commercial applications. Center or one-way draw, Pinch Pleat or Ripplefold and 5 System Styles. Select from 35 Portfolio Hand Painted Finishes (**except Antique Gold Leaf**), PTH Perfect Match™ or 6 Quick Ship Metal Finishes. Coordinates best with our NEW 1 1/8" Modern Metal Collection Finials, but all 1 1/8" Finial Collections require the Transitional or Deco Cuff / Finial Adapter to work with Baton Draw Metal Traverse (sold separately).

1 1/8" Baton Draw Metal Traverse | System Styles new

Traverse Systems include track, brackets, master carriers, glides and Emery end caps. Finials and transitional or deco cuffs / finial adapters sold separately. See Retail Price List for more traverse system details.

Available colors
for components

White

Bronze



Single Traverse System
Wall Mount

Wall Bracket is available in
3 1/2" or 6" return options.

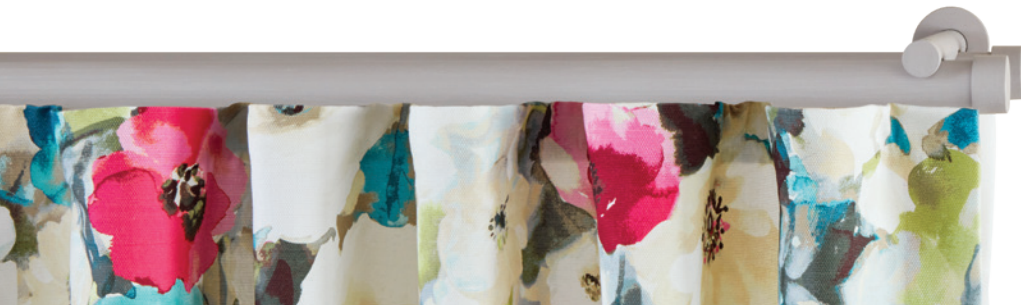

Double Traverse System
Wall Mount

Wall Bracket is available in
3" and 7 1/2" returns.



Single Traverse System
Ceiling Mount

Ceiling Bracket is available in
3 5/16" drop.



Double Traverse System
Ceiling Mount

Ceiling Bracket is available in
3 11/16" drop with 4 1/2" between
centers of tracks.



Single Traverse System
Low-Profile Ceiling Mount

Ceiling Bracket is available in
1 3/16" drop.

1 1/8" Baton Draw Metal Traverse | Overview new

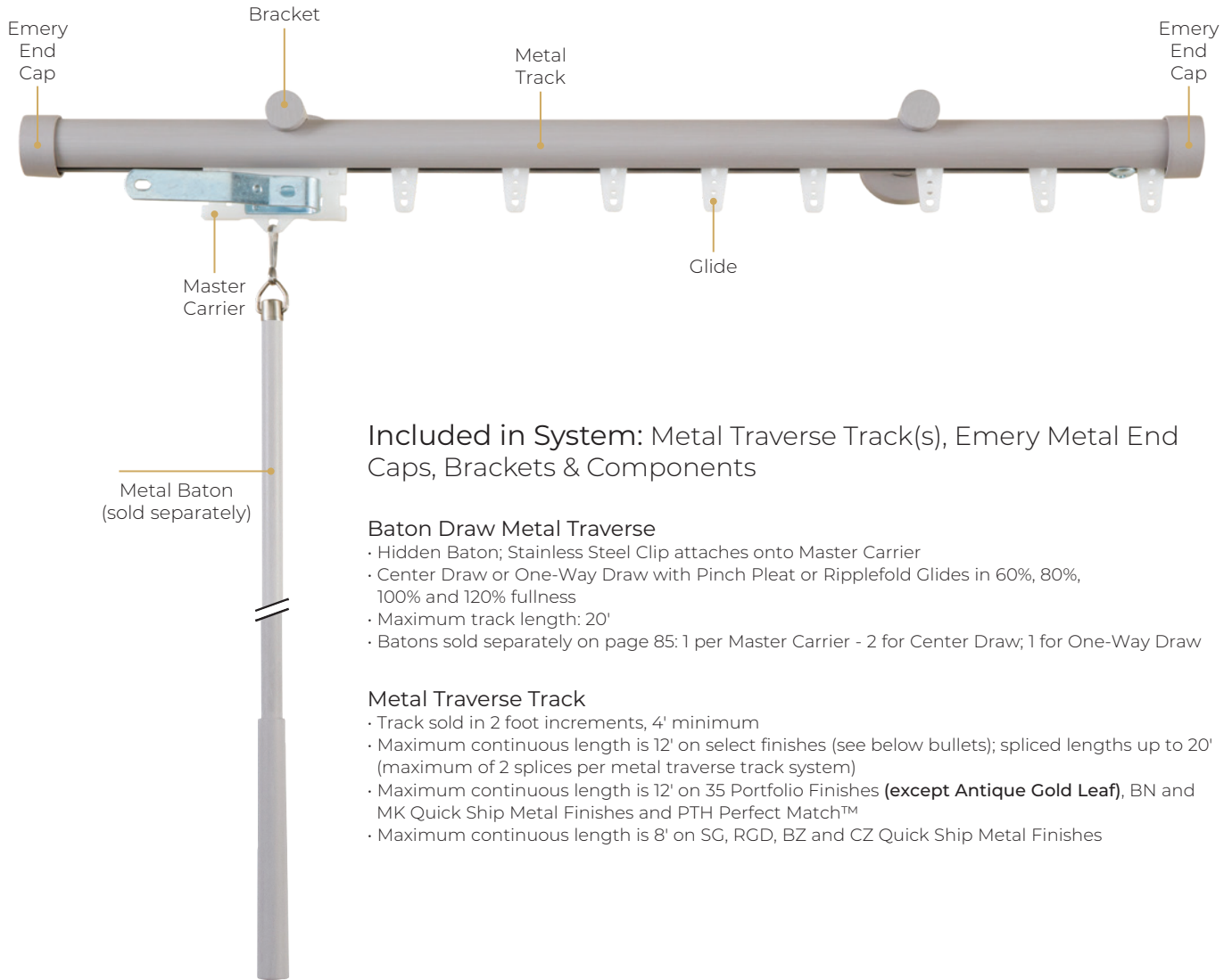

Included in System: Metal Traverse Track(s), Emery Metal End Caps, Brackets & Components

Baton Draw Metal Traverse

- Hidden Baton; Stainless Steel Clip attaches onto Master Carrier
- Center Draw or One-Way Draw with Pinch Pleat or Ripplefold Glides in 60%, 80%, 100% and 120% fullness
- Maximum track length: 20'
- Batons sold separately on page 85: 1 per Master Carrier - 2 for Center Draw; 1 for One-Way Draw

Metal Traverse Track

- Track sold in 2 foot increments, 4' minimum
- Maximum continuous length is 12' on select finishes (see below bullets); spliced lengths up to 20' (maximum of 2 splices per metal traverse track system)
- Maximum continuous length is 12' on 35 Portfolio Finishes (**except Antique Gold Leaf**), BN and MK Quick Ship Metal Finishes and PTH Perfect Match™
- Maximum continuous length is 8' on SG, RGD, BZ and CZ Quick Ship Metal Finishes

Features



Child & Pet Safe Environment

Batons eliminate any physical operating cords, ensuring the ones we care about most are protected and safe - comfort and convenience to suit your lifestyle.



Easy Draw Operation

The perfect modern solution for residential or commercial applications. When traversing with batons, glide draperies by holding the baton but not pulling down on the baton.



ADA Compliant Options

Metal and Clear Acrylic Baton options with 4" loops for Handicap Accessibility, still available in 35 Hand Painted Portfolio Finishes, 6 Quick Ship Metal Finishes or PTH Perfect Match™.



Available in a Range of Lengths

The length of the baton should be long enough to be easily reached by the end user. Select from 36", 48" or 60" for Metal or Clear Acrylic Batons, or 48" or 60" for Handicap Batons.

See Retail Price List for more traverse system details.

1 1/8" Baton Draw Metal Traverse | Batons new



Metal Batons
36" POME36WAND QSME36WAND
48" POME48WAND QSME48WAND
60" POME60WAND QSME60WAND
3/8" DIA, Metal, Concrete

new **Handicap Metal Baton**
48" POME48HWAND QSME48HWAND
60" POME60HWAND QSME60HWAND
4" Loop, ADA Compliant, Metal, Concrete
Available in all 35 Portfolio finishes or PTH Perfect Match™
Quick Ship Finishes Available: BN, BZ & MK



Clear Acrylic Batons
36" AC36WAND
48" AC48WAND
60" AC60WAND
1/2" DIA, Acrylic



new **Handicap Clear Acrylic Batons**
48" AC48HWAND
60" AC60HWAND
72" AC72HWAND
4" Loop, ADA Compliant, Acrylic



Designer
Expertise

Use a double bracket to easily create a two layer treatment -the design possibilities are limitless! »



Batons Sold Separately; select from Metal Batons, Handicap Metal Batons, Clear Acrylic Batons or Handicap Clear Acrylic Batons »

Traverse Systems: Manual 1 1/8"

1 1/8" Baton Draw Metal Traverse | Brackets & Accessories new



new **Wall Mount Single**
PTHMT118400
1 7/8" DIA backplate, 3 1/2" return
Metal, Concrete



new **Wall Mount 6" Single**
PTHMT118401
1 7/8" DIA backplate, 6" return
Metal, Concrete



new **Wall Mount Double**
PTHMT118402
1 7/8" DIA backplate, 7 1/2" front return and
3" back return
Metal, Concrete



Finish »
Concrete



new **Ceiling Mount Single**
PTHMT118403
1 7/8" DIA backplate,
3 5/16" drop
Metal, Concrete



new **Ceiling Mount Double**
PTHMT118404
4 1/2" between centers of tracks,
1 7/8" DIA backplate, 3 11/16" drop
Metal, Concrete



new **Ceiling Bracket Extender**
PTHMT118405
2" drop
Metal, Concrete



new **Low-Profile Ceiling Single**
PTHMT118406
1 3/4" L x 3/4" W, 1 3/16" drop
Metal, Concrete



new **Hinged Elbow**
PTHMT118409
1 1/8" DIA, 1 3/4" overall
length, 1 7/16" L each
side when bent
Metal, Concrete



new **Connector / Splice**
PTHMT118407
Brass only

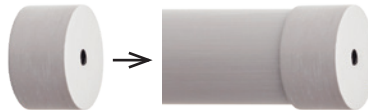

new **1 1/8" Transitional Cuff / Finial Adapter**
PO118CUFF QS118CUFF
3/4" L x 1 3/4" W

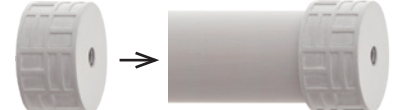

new **1 1/8" Deco Cuff / Finial Adapter**
PO118DECUFF QS118DECUFF
3/4" L x 1 3/8" W

- Metal, Available in any of our 35 Portfolio Hand Painted Finishes, 6 Quick Ship Metal Finishes or PTH Perfect Match™
- Mix & Match finishes and materials for the ultimate customized style, or use to adapt your 1 3/8" Today's Traditional or Heritage Classics Finial to work with Metal Traverse

See Retail Price List for more traverse system details.

1 1/8" Baton Draw Metal Traverse | Carriers new



Pinch Pleat Master Carrier
BT3005R or BT3005L

Stainless steel overlap arms with multi-wheel design for smooth movement. Available in white or bronze /BR and left or right.

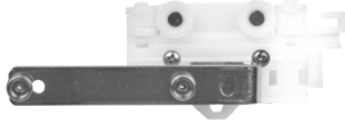

Ripplefold Overlap Master Carrier
BT3125R or BT3125L

Stainless steel overlap arms with snaps to accept Ripplefold tape and a multi-wheel design for smooth movement. Available in white or bronze /BR and left or right.

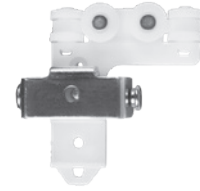

Ripplefold Butt Master Carrier
BT3600R or BT3600L

Arms with snaps to accept Ripplefold tape and a multi-wheel design for smooth movement. Butt Master Carriers do not overlap, allowing light to filter between draperies on center draw treatments. Must be specified for substitution. Available in white or bronze /BR and left or right.

Pinch Pleat



Ripplefold



Pinch Pleat Glide
CP10 or CP10/BR

Ball Bearing Wheel for smooth movement. Available in white or bronze /BR.

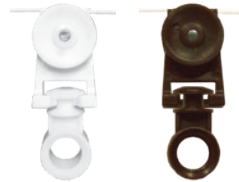

Ripplefold Glide

R4060	R4060/BR	60% fullness
R4080	R4080/BR	80% fullness
R4100	R4100/BR	100% fullness
R4120	R4120/BR	120% fullness

Ripplefold Glides with detachable pendants. Available in white or bronze /BR.



Glide Stop
BT4333

Available in stainless steel only.

See Retail Price List for more traverse system details.

Style Meets Function

Upgrade your End Cap with Finial Styles



Wright - Crystal

Metal / Crystal,
Concrete

Transitional Style

new 1 1/8" Transitional Cuff / Finial Adapter

PO118CUFF QS118CUFF

3/4" L x 1 1/4" W

- Metal, Available in any of our 35 Portfolio Hand Painted Finishes, 6 Quick Ship Metal Finishes or PTH Perfect Match™
- Mix & Match finishes and materials for the ultimate customized style, or use to adapt your 1 1/8" Finial to work with Metal Traverse



Transitional Cuff on 1 1/8" Baton Draw Metal Traverse in Shimmer finish

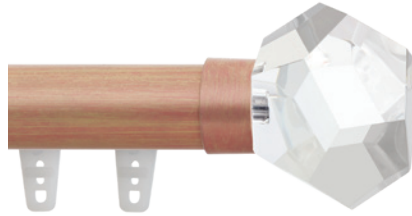

Reese - Crystal Finial with Transitional Cuff in Blush finish

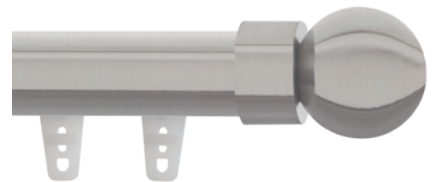

Ella Finial with Transitional Cuff in Brushed Nickel finish

Clean Deco Style

new 1 1/8" Deco Cuff / Finial Adapter

PO118DECUFF QS118DECUFF

3/4" L x 1 3/8" W

- Metal, Available in any of our 35 Portfolio Hand Painted Finishes, 6 Quick Ship Metal Finishes or PTH Perfect Match™
- Mix & Match finishes and materials for the ultimate customized style, or use to adapt your 1 1/8" Finial to work with Metal Traverse

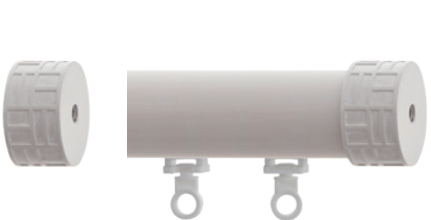

Deco Cuff on 1 1/8" Baton Draw Metal Traverse in Concrete finish



Penelope Finial with Deco Cuff in Brushed Bronze finish

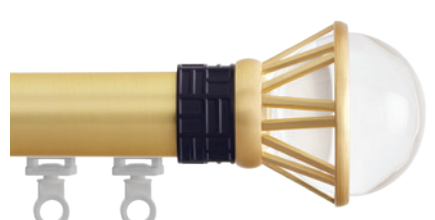

Dakota - Crystal Finial in Satin Gold finish with Deco Cuff in Matte Black finish

1 1/8" Baton Draw Metal Traverse | Finials new

1 1/8" Baton Draw Metal Traverse Systems include End Caps, but are designed to work with all 1 1/8" Finials across five style categories using either Cuff / Finial Adapter.



Portfolio pages 12 - 13 | Quick Ship pages 108 - 109 | **Requires Transitional or Deco Cuff / Finial Adapter*



Portfolio pages 14 - 15 | Quick Ship pages 110 - 111 | **Requires Transitional or Deco Cuff / Finial Adapter*



Portfolio pages 16 - 17 | Quick Ship page 111 | **Requires Transitional or Deco Cuff / Finial Adapter*



Portfolio pages 18 - 19 | **Requires Transitional or Deco Cuff / Finial Adapter*



Portfolio pages 20 - 21 | **Requires Transitional or Deco Cuff / Finial Adapter*

How To Add Your Cuff / Finial Adapter »

- 1 Select your Cuff style and finish - Mix & Match for the ultimate customization.
- 2 Place Cuff onto metal traverse and tighten set screw with Allen Wrench.
- 3 Install finials by screwing into the Cuff / Finial Adapter.



Finish »
Matte
Black



1 3/8" Baton Draw Metal Traverse new

The perfect modern solution for residential or commercial applications. Center or one-way draw, Pinch Pleat or Ripplefold and 5 System Styles. Select from 35 Portfolio Hand Painted Finishes (**except Antique Gold Leaf**), PTH Perfect Match™, 6 Quick Ship Metal Finishes or 5 Quick Ship Wood & Resin Finishes. Coordinates best with our NEW 1 3/8" Modern Metal Collection Finials, but 1 3/8" Today's Traditional Collection Finials and Heritage Classics Collection Finials require the Transitional Cuff / Finial Adapter PO138CUFF or QS138CUFF (sold separately) to work with Metal Traverse.

1 3/8" Baton Draw Metal Traverse | System Styles new

Traverse Systems include track, brackets, master carriers, glides and Ainsley end caps. Finials and transitional cuffs / finial adapters sold separately. See Retail Price List for more traverse system details.

Available colors for components

White

Bronze



Single Traverse System Wall Mount

Wall Bracket is available in 3 1/2" or 6" return options.



Double Traverse System Wall Mount

Wall Bracket is available in 3" and 7 1/2" returns.



Single Traverse System Ceiling Mount

Ceiling Bracket is available in 3 11/16" drop.



Double Traverse System Ceiling Mount

Ceiling Bracket is available in 4" drop with 4 1/2" between centers of tracks.



Single Traverse System Low-Profile Ceiling Mount

Ceiling Bracket is available in 1 1/2" drop.

1 3/8" Baton Draw Metal Traverse | Overview new

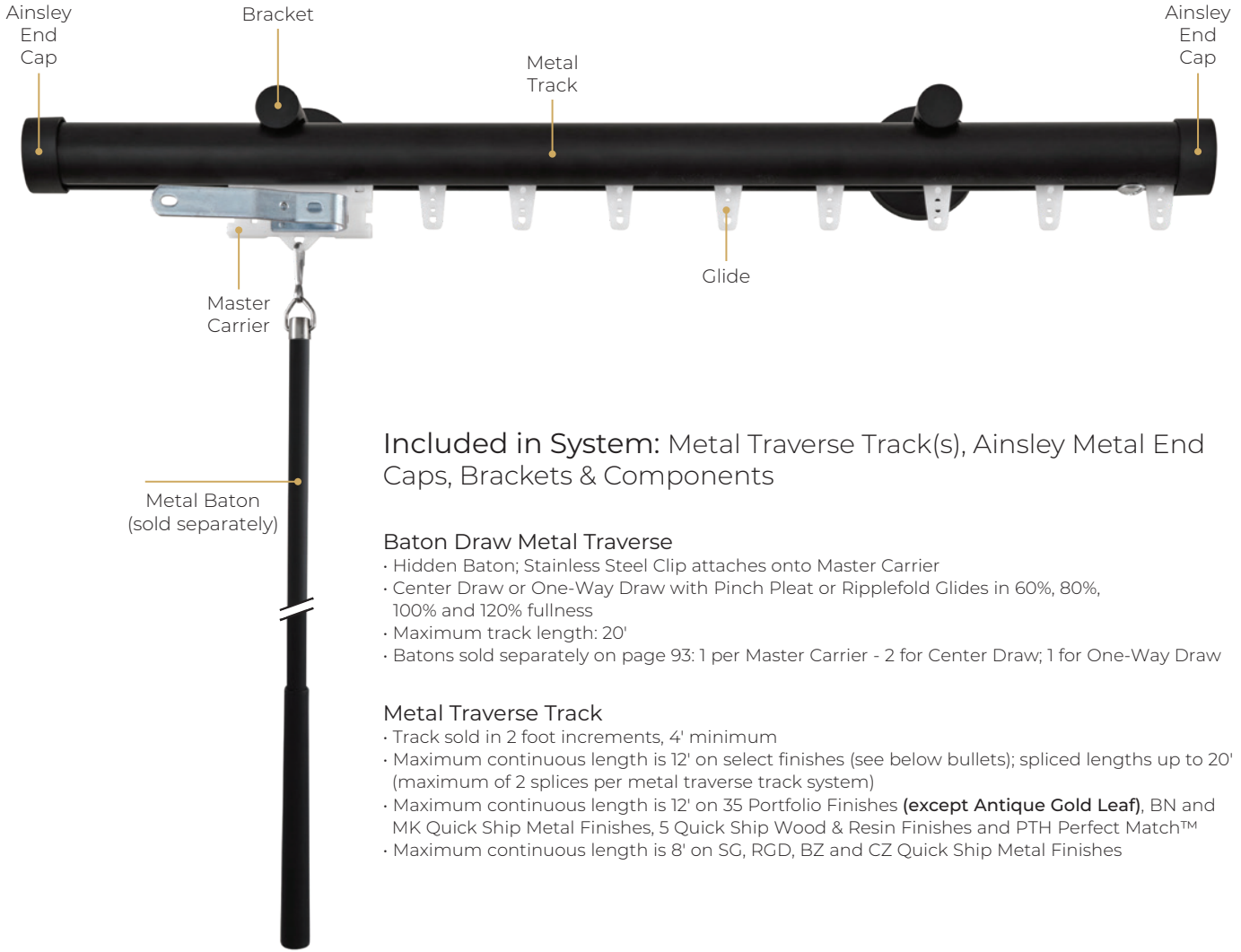

Included in System: Metal Traverse Track(s), Ainsley Metal End Caps, Brackets & Components

Baton Draw Metal Traverse

- Hidden Baton; Stainless Steel Clip attaches onto Master Carrier
- Center Draw or One-Way Draw with Pinch Pleat or Ripplefold Glides in 60%, 80%, 100% and 120% fullness
- Maximum track length: 20'
- Batons sold separately on page 93: 1 per Master Carrier - 2 for Center Draw; 1 for One-Way Draw

Metal Traverse Track

- Track sold in 2 foot increments, 4' minimum
- Maximum continuous length is 12' on select finishes (see below bullets); spliced lengths up to 20' (maximum of 2 splices per metal traverse track system)
- Maximum continuous length is 12' on 35 Portfolio Finishes (**except Antique Gold Leaf**), BN and MK Quick Ship Metal Finishes, 5 Quick Ship Wood & Resin Finishes and PTH Perfect Match™
- Maximum continuous length is 8' on SG, RGD, BZ and CZ Quick Ship Metal Finishes

Features



Child & Pet Safe Environment

Batons eliminate any physical operating cords, ensuring the ones we care about most are protected and safe - comfort and convenience to suit your lifestyle.



Easy Draw Operation

The perfect modern solution for residential or commercial applications. When traversing with batons, glide draperies by holding the baton but not pulling down on the baton.



ADA Compliant Options

Metal and Clear Acrylic Baton options with 4" loops for Handicap Accessibility, still available in 35 Hand Painted Portfolio Finishes, 6 Quick Ship Metal Finishes, 5 Quick Ship Wood & Resin Finishes or PTH Perfect Match™.



Available in a Range of Lengths

The length of the baton should be long enough to be easily reached by the end user. Select from 36", 48" or 60" for Metal or Clear Acrylic Batons, or 48" or 60" for Handicap Batons.

See Retail Price List for more traverse system details.

1 3/8" Baton Draw Metal Traverse | Batons new



Metal Batons

- 36" POME36WAND QSME36WAND
- 48" POME48WAND QSME48WAND
- 60" POME60WAND QSME60WAND
- 3/8" DIA, Metal, Matte Black



Clear Acrylic Batons

- 36" AC36WAND
- 48" AC48WAND
- 60" AC60WAND
- 1/2" DIA, Acrylic



new Handicap Metal Baton

- 48" POME48HWAND QSME48HWAND
- 60" POME60HWAND QSME60HWAND
- 4" Loop, ADA Compliant, Metal, Matte Black
- Available in all 35 Portfolio finishes, BN, BZ & MK Quick Ship Metal Finishes, 5 Quick Ship Wood & Resin Finishes or PTH Perfect Match™



new Handicap Clear Acrylic Batons

- 48" AC48HWAND
- 60" AC60HWAND
- 72" AC72HWAND
- 4" Loop, ADA Compliant, Acrylic



Designer
Expertise

Ceiling Mount Brackets work well for projects where there isn't enough wall space for a wall bracket, allowing the treatment to drop down from the ceiling »

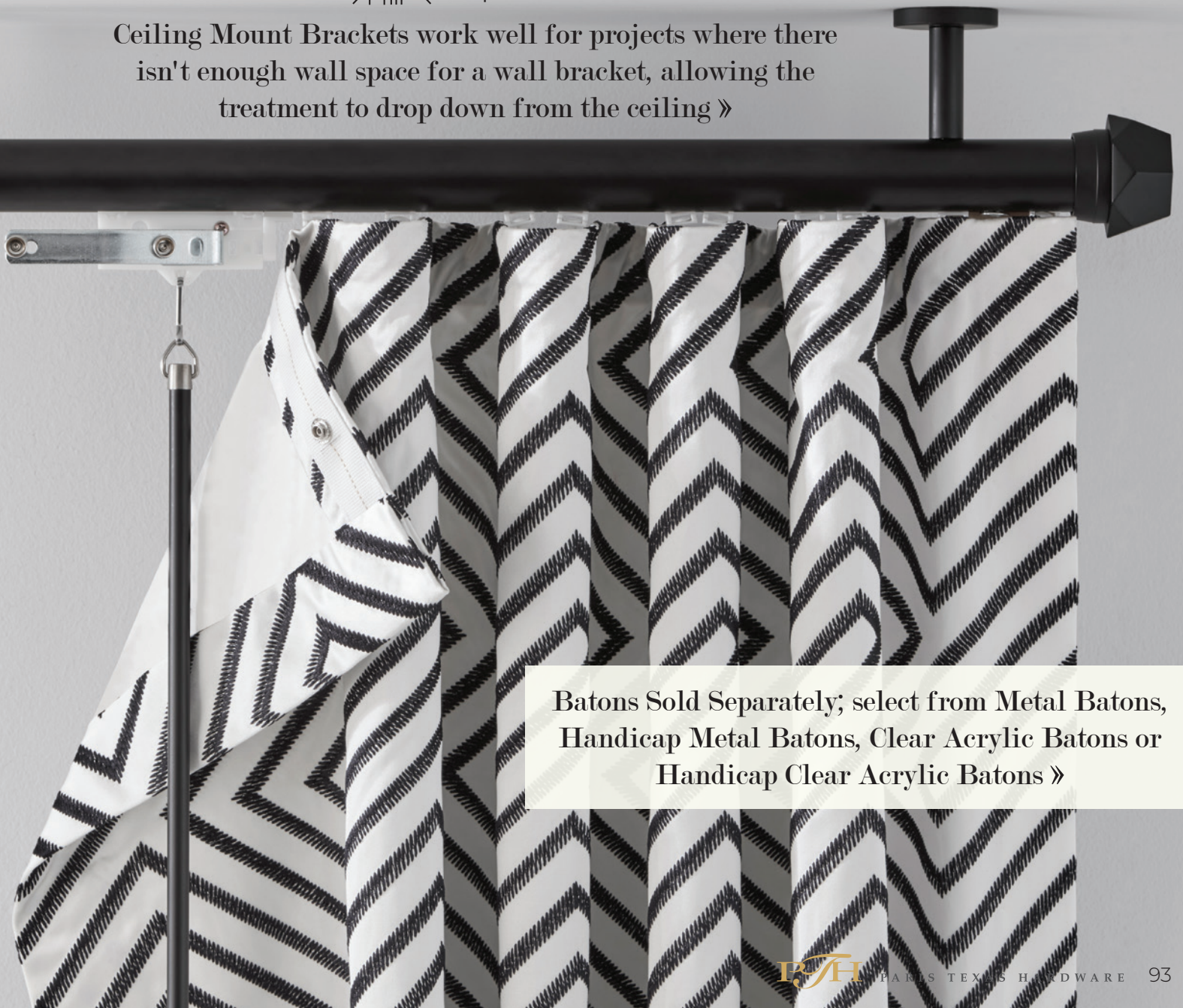

Batons Sold Separately; select from Metal Batons, Handicap Metal Batons, Clear Acrylic Batons or Handicap Clear Acrylic Batons »

Traverse Systems: Manual 1 3/8"

1 3/8" Baton Draw Metal Traverse | Brackets & Accessories new



new Wall Mount Single
PTHMT138400
2 7/16" DIA backplate, 3 1/2" return
Metal, Matte Black



new Wall Mount 6" Single
PTHMT138401
2 7/16" DIA backplate, 6" return
Metal, Matte Black



new Wall Mount Double
PTHMT138402
2 7/16" DIA backplate, 7 1/2" front return and
3" back return
Metal, Matte Black



new Ceiling Mount Single
PTHMT138403
1 7/8" DIA backplate,
3 1/4" drop
Metal, Matte Black



new Ceiling Mount Double
PTHMT138404
4 1/2" between centers of tracks,
1 7/8" DIA backplate, 4" drop
Metal, Matte Black



new Ceiling Bracket Extender
PTHMT138405
2" drop
Metal, Matte Black



new Low-Profile Ceiling Single
PTHMT138406
1 3/4" L x 3/4" W, 1 1/2" drop
Metal, Matte Black



new Hinged Elbow
PTHMT138409
1 3/8" DIA, 2" overall
length, 1 1/16" L each
side when bent
Metal, Matte Black



new Connector / Splice
PTHMT138407



new 1 3/8" Transitional Cuff / Finial Adapter
PO138CUFF Q5138CUFF
3/4" L x 1 1/2" W
• Metal, Available in any of our 35 Portfolio Hand Painted Finishes,
5 Quick Ship Wood & Resin Finishes or PTH Perfect Match™
• Required to adapt your 1 3/8" Today's Traditional or Heritage Classics
Finials to work with Metal Traverse, sold separately

See Retail Price List for more traverse system details.

1 3/8" Baton Draw Metal Traverse | Carriers new



Pinch Pleat Master Carrier
BT3005R or BT3005L

Stainless steel overlap arms with multi-wheel design for smooth movement. Available in white or bronze /BR and left or right.

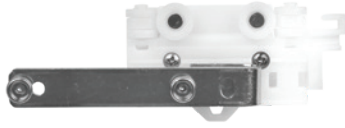

Ripplefold Overlap Master Carrier
BT3125R or BT3125L

Stainless steel overlap arms with snaps to accept Ripplefold tape and a multi-wheel design for smooth movement. Available in white or bronze /BR and left or right.

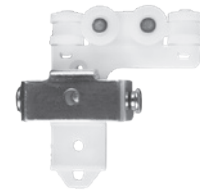

Ripplefold Butt Master Carrier
BT3600R or BT3600L

Arms with snaps to accept Ripplefold tape and a multi-wheel design for smooth movement. Butt Master Carriers do not overlap, allowing light to filter between draperies on center draw treatments. Must be specified for substitution. Available in white or bronze /BR and left or right.

Pinch Pleat



Ripplefold



Pinch Pleat Glide
CP10 or CP10/BR

Ball Bearing Wheel for smooth movement. Available in white or bronze /BR.

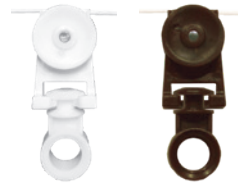

Ripplefold Glide

R4060	R4060/BR	60% fullness
R4080	R4080/BR	80% fullness
R4100	R4100/BR	100% fullness
R4120	R4120/BR	120% fullness

Ripplefold Glides with detachable pendants. Available in white or bronze /BR.



Glide Stop
BT4333

Available in stainless steel only.

See Retail Price List for more traverse system details.

Style Meets Function



Exton

Metal, Matte Black

Upgrade your End Cap with Finial Styles

new 1 3/8" Transitional Cuff / Finial Adapter

PO138CUFF QSI38CUFF

3/4" L x 1 1/2" W

- Metal, Available in any of our 35 Portfolio Hand Painted Finishes, 5 Quick Ship Wood & Resin Finishes or PTH Perfect Match™
- Required to adapt your 1 3/8" Today's Traditional or Heritage Classics Finials to work with Metal Traverse, sold separately

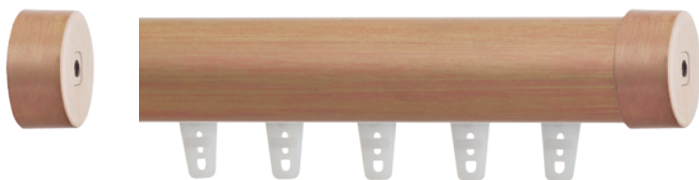

Transitional Cuff in Blush finish on 1 3/8" Baton Draw Metal Traverse

Style Meets Function

1 3/8" Today's Traditional and Heritage Classics Finials require the Transitional Cuff / Finial Adapter.

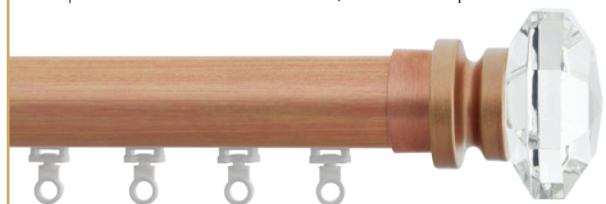

Rose - Crystal Finial with Transitional Cuff in Blush finish

1 3/8" Baton Draw Metal Traverse | Finials new

1 3/8" Baton Draw Metal Traverse Systems include End Caps, but are designed to work with all 1 3/8" Finials across three style categories. Today's Traditional and Heritage Classics Finials require the use of the Transitional Cuff / Finial Adapter to work with Metal Traverse. Modern Finials do not require the use of the Finial Adapter.



Portfolio pages 28 - 29 | Quick Ship pages 116 - 117 | **Transitional Cuff / Finial Adapter not required*



Portfolio pages 34 - 35 | Quick Ship pages 122 - 123 | **Requires Transitional Cuff / Finial Adapter PO138CUFF or QS138CUFF*



Portfolio pages 36 - 37 | Quick Ship pages 124 - 125 | **Requires Transitional Cuff / Finial Adapter PO138CUFF or QS138CUFF*

How To Add Your Transitional Cuff / Finial Adapter »

- 1 Select your Cuff style and finish - Mix & Match for the ultimate customization.
- 2 Place Cuff onto metal traverse and tighten set screw with Allen Wrench.
- 3 Install finials by screwing into the Cuff / Finial Adapter.



Finish »
Spun Gold



Heavy Duty Corded or Baton Traverse new

Heavy Duty System is recommended for heavier treatments with lining. Longer lengths are versatile for residential or commercial projects. Center or one-way draw, Pinch Pleat or Ripplefold and 4 System Styles. Decorative wood fascia available in 1 3/8" or 2 1/4" smooth, reeded or grooved / fluted profiles with coordinating finials, 1 7/8" slim round smooth profile, 2 1/4" flat smooth profile with flush ends or mitered returns. Select from 35 Portfolio Hand Painted Finishes, PTH Perfect Match™ or 5 Quick Ship Wood and Resin Finishes.

Heavy Duty Corded or Baton Traverse | System Styles new

Traverse Systems include track, brackets, master carriers and glides. See below descriptions for more details. All traverse systems are available with or without decorative wood fascia. Finials are sold separately. 1 3/8" or 2 1/4" Portfolio and Quick Ship Wood and Resin Finials are compatible. C-Rings available with Pinch Pleat. See Retail Price List for more traverse system details.

Available colors for heavy duty track, brackets and components

White

Bronze



Single Traverse System
Wall or Ceiling Mount

Traverse Systems include track, brackets and glides. Wood fascia option available.



Double Traverse System
Wall or Ceiling Mount

Traverse Systems include track, brackets and glides. Wood fascia option available for front and back.



Single or Double Traverse System with Mitered Returns

Traverse Systems include track, brackets and glides. Wood fascia options available for front and back. Mitered returns sold separately.



Double Traverse System with Back Traverse & Stationary Pole in Front

Traverse Systems include track, stationary pole, brackets and glides. Wood fascia for back track available.

Heavy Duty Corded or Baton Traverse | Overview new

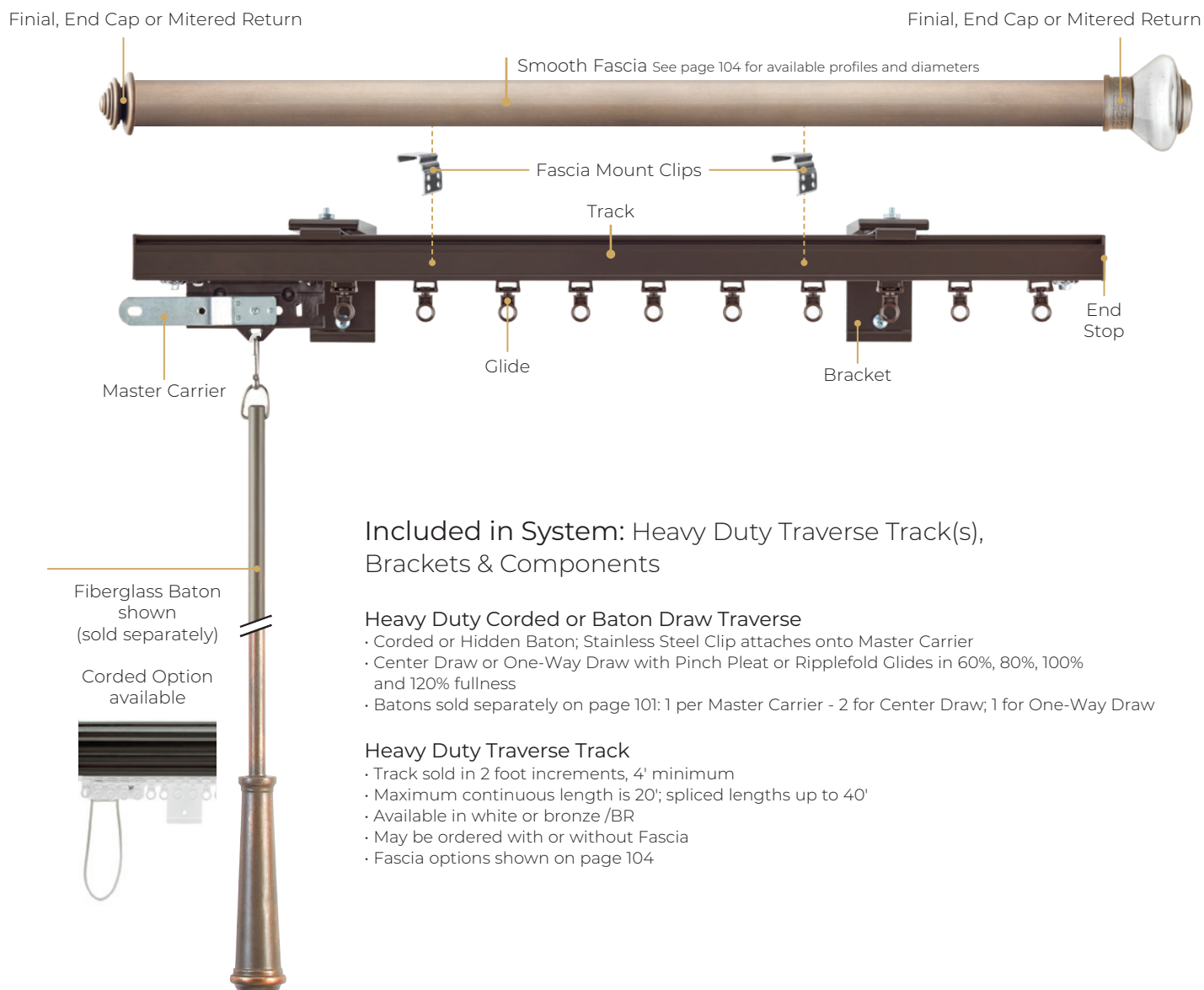

Included in System: Heavy Duty Traverse Track(s), Brackets & Components

Heavy Duty Corded or Baton Draw Traverse

- Corded or Hidden Baton; Stainless Steel Clip attaches onto Master Carrier
- Center Draw or One-Way Draw with Pinch Pleat or Ripplefold Glides in 60%, 80%, 100% and 120% fullness
- Batons sold separately on page 101: 1 per Master Carrier - 2 for Center Draw; 1 for One-Way Draw

Heavy Duty Traverse Track

- Track sold in 2 foot increments, 4' minimum
- Maximum continuous length is 20'; spliced lengths up to 40'
- Available in white or bronze /BR
- May be ordered with or without Fascia
- Fascia options shown on page 104

Features



Heavy Duty = Don't Worry!

Recommended for heavier fabrics with lining or treatments mounted 10' from the floor, providing comfort for your customized draperies.



Easy Draw Operation

Two heavy duty track profiles provide the ease you're looking for when it comes to draperies, and the ability to move when and how you want.



Stylized Fascia Profiles

Availability of Smooth, Reeded, Grooved / Fluted, Slim Round Smooth, Flat Smooth or Mitered Returns, the possibilities are endless!



C-Ring System Available

With three diameters available, C-Rings offer the ease of pinch pleat traverse while keeping your finish safe from harm, providing style and functionality.

See Retail Price List for more traverse system details.



Designer
Expertise



Easy to install; new & improved brackets »



Stella

Resin, Spun Gold

Heavy Duty Corded or Baton Traverse | Batons new



new

Fiberglass Batons

36" PORE36WAND QSRE36WAND
48" PORE48WAND QSRE48WAND
60" PORE60WAND QSRE60WAND
3/8" DIA, Fiberglass, Spun Gold



Clear Acrylic Batons

36" AC36WAND
48" AC48WAND
60" AC60WAND
1/2" DIA, Acrylic



new

Handicap Clear Acrylic Batons

48" AC48HWAND
60" AC60HWAND
72" AC72HWAND
4" Loop, ADA Compliant, Acrylic

Heavy Duty Corded or Baton Traverse | Finials new

Finials are sold separately. 1 3/8" or 2 1/4" Portfolio and Quick Ship Wood and Resin finials are compatible across two style categories.



1 3/8" Portfolio pages 34 - 35 | 1 3/8" Quick Ship pages 122 - 123 | 2 1/4" Portfolio pages 41 - 43 | 2 1/4" Quick Ship pages 130 - 131



1 3/8" Portfolio pages 36 - 37 | 1 3/8" Quick Ship pages 124 - 125 | 2 1/4" Portfolio pages 44 - 46 | 2 1/4" Quick Ship pages 132 - 133

Traverse Systems: Manual 1 3/8" - 2 1/4"

Heavy Duty Corded or Baton Traverse | Carriers new

Glides are available for standard Pinch Pleat or Ripplefold® Style treatments. For more details on pinch pleat and Ripplefold glides, please see the price list.

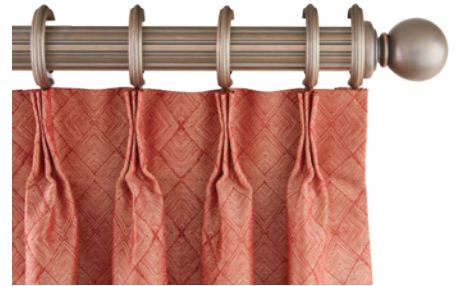

Pinch Pleat Glides

CP10 CP10/BR

Ball Bearing Wheel for smooth movement. Available in white or bronze /BR.



Ripplefold® Style Glides

R4060	R4060/BR	60% fullness
R4080	R4080/BR	80% fullness
R4100	R4100/BR	100% fullness
R4120	R4120/BR	120% fullness

Ripplefold Glides with detachable pendants. Available in white or bronze /BR.



C-Rings

138CR 2" ID, 3 1/4" OD
214CR 3 1/8" ID, 4 3/8" OD

Available in all 35 Portfolio custom hand painted finishes, 5 Quick Ship Wood & Resin finishes or PTH Perfect Match™.

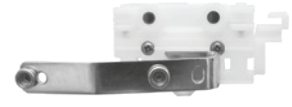
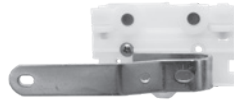
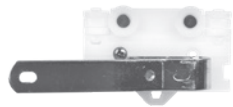

Baton Pinch Pleat Master Carrier
BT3005R or BT3005L

Corded Pinch Pleat Master Carrier
CD3300R or CD3300L

Baton Ripplefold Overlap Master Carrier
BT3125R or BT3125L

Corded Ripplefold Overlap Master Carrier
CD3412R or CD3412L

Stainless steel overlap arms with multi-wheel design for smooth movement. Available in white or bronze /BR and left or right.

Stainless steel overlap arms with snaps to accept Ripplefold tape and a multi-wheel design for smooth movement. Available in white or bronze /BR and left or right.

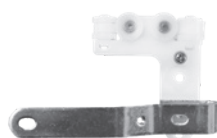

Baton Pinch Pleat C-Ring Master Carrier
BT3501R or BT3501L

Corded Pinch Pleat C-Ring Master Carrier
CD3500R or CD3500L

Baton Ripplefold Butt Master Carrier
BT3600R or BT3600L

Corded Ripplefold Butt Master Carrier
CD3600R or CD3600L

Stainless steel overlap arms with multi-wheel design for smooth movement. Available in white or bronze /BR and left or right.

Arms with snaps to accept Ripplefold tape and a multi-wheel design for smooth movement. Butt Master Carriers do not overlap, allowing light to filter between draperies on center draw treatments. Must be specified for substitution. Available in white or bronze /BR and left or right.

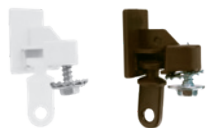

Baton Pinch Pleat End Cap
BT4013

Baton Ripplefold End Cap
BT4123

Corded Universal End Pulley Body
CD4311R or CD4311L

Corded One-Way End Pulley Body
CD4310R or CD4310L

Available in white or bronze /BR.

Available in white or bronze /BR.

Pendants sold separately. Available in white or bronze /BR and left or right.

Pendants sold separately. Available in white or bronze /BR and left or right.

See Retail Price List for more traverse system details.

Heavy Duty Corded or Baton Traverse | Brackets new

Components are white; to order components in bronze, add /BR

Corded



HD Corded Single
TB035-H

2 11/16" H x 1 1/2" W backplate, adjustable up to 5 1/2" return
Available in white or bronze /BR.



HD Corded Single or Double
TB060-H

3 5/16" H x 1 1/2" W backplate, adjustable 6" - 7 1/2" front return and 3" back return
Available in white or bronze /BR.



HD Corded Single, Double or Triple
TB100-H

4 1/2" H x 1 1/2" W backplate, adjustable up to 11 3/4" return
Available in white or bronze /BR.



HD Corded Fascia Mount Clip
CD4001FC

1/2" H x 1" W

Use to attach fascia to corded traverse systems; included. Available in zinc.



HD Corded Ceiling Mount Clip Single
CD533

5/8" H x 2 5/8" D x 7/8" W

May only be used in corded systems without fascia - *for double ceiling mount installation, install two brackets into ceiling.* Available in white.

Baton



HD Baton Single
TB035-HB

2 11/16" H x 1 1/2" W backplate, adjustable up to 4" return
Available in white or bronze /BR.



HD Baton Single or Double
TB060-HB

3 3/8" H x 1 1/2" W backplate, adjustable 5 1/4" - 6" front return and adjustable 2 1/4" - 3 1/8" back return
Available in white or bronze /BR.



HD Baton Single, Double or Triple
TB100-HB

4 1/2" H x 1 1/2" W backplate, adjustable up to 9 3/4" return
Available in white or bronze /BR.



HD Baton Fascia Mount Clip
BT4003NFC

1/2" H x 1" W

Use to attach fascia to baton traverse systems; included. Available in zinc.



HD Baton Ceiling Mount Clip Single
BT5333

1/4" H x 2 1/4" D x 1" W

May only be used in baton systems without fascia - *for double ceiling mount installation, install two brackets into ceiling.* Available in white.

Corded and Baton



HD Custom Over-Bracket Single
TBKT214-H (Corded) TBKT214-HB (Baton)

3 1/2" H x 3/4" W backplate, 7 7/8" front return and 3" back return
Use to combine 2 1/4" full wood pole with single traverse systems; includes traverse ceiling mount bracket attached onto the bottom of the over-bracket. Fascias sold separately. Available in any of our 35 hand painted Portfolio finishes, 5 Quick Ship Wood & Resin finishes or your own custom PTH Perfect Match™ finish.
Steel, Spun Gold



HD Custom Ceiling Single
CMTB-H CMTB-HB

2 3/4" H x 3/4" W backplate
Specify drop: contingent upon which fascia or finials are chosen - *for double ceiling mount installation, install two brackets into ceiling.*
Steel, Spun Gold



Drapery Return Bracket
CP500

9/16" H x 1/2" W backplate, 1 3/4" return
Allows for return on track hardware in traverse systems; included.
Available in zinc only.

See Retail Price List for more traverse system details, including diagrams & specifications for brackets.

Traverse Systems: Fascias

Heavy Duty Corded or Baton Traverse | Fascia Profiles

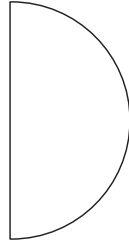

Smooth

- 1 3/8" and 2 1/4" diameters available
- See page 101 for coordinating finial options

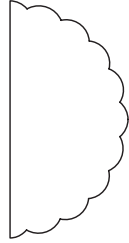

Reeded

- 1 3/8" and 2 1/4" diameters available
- See page 101 for coordinating finial options



Grooved / Fluted

- 1 3/8" and 2 1/4" diameters available
- See page 101 for coordinating finial options



Slim Round Smooth, No Finials

- 1 7/8" diameter, available with flush ends or mitered returns



Flat Smooth, No Finials

- 2 1/4" height, available with flush ends or mitered returns



Mitered Returns (sold separately)

- 1 3/8", 1 7/8" and 2 1/4" diameters available
- All profiles



Designer
Expertise

For a more finished look or the perfect solution for covering bay or corner windows, add mitered returns to your fascia »

Finish » Spun Gold



Quick Ship Collection

Quick Ship Metal Finishes *ships within 24 hours*



Brushed Nickel BN



Satin Gold SG



Rose Gold RGD



Brushed Bronze BZ



Charcoal Zinc CZ



Matte Black MK

Quick Ship Finial Collections available in Metal Finishes »

- 1 1/8" Modern
- 1 1/8" Clean Deco
- 1 1/8" Transitional Luxe
- 1 3/8" Modern

Quick Ship Traverse Systems available in Metal Finishes »

- 1 3/8" R-TEC Motorized Metal Traverse
- 1 1/8" Baton Draw Metal Traverse
- 1 3/8" Baton Draw Metal Traverse

Quick Ship Wood & Resin Finishes *ships within 24 hours*



Platinum
PL



Rose Gold
RG



Antique Brass
AB



Walnut
WAL



Oil Rubbed Bronze
ORB

Quick Ship Finial Collections available in Wood & Resin Finishes »

- 1 3/8" Today's Traditional
- 1 3/8" Heritage Classics
- 2 1/4" Today's Traditional
- 2 1/4" Heritage Classics

Quick Ship Traverse Systems available in Wood & Resin Finishes »

- R-TEC Motorized Heavy Duty Traverse
- Somfy Motorized Heavy Duty Traverse
- Heavy Duty Corded or Baton Draw Traverse



When you need something in a hurry, our quick ship collections ship out within 24 hours!

- » You get it fast!
- » Always fully stocked and ready to be packed and shipped immediately upon ordering.
- » New! 6 stunning plated Metal Finishes. Whether you are looking for a finish that's more modern like Brushed Nickel, or transitional like Brushed Bronze, select from a variety of trend-right finishes designed to inspire.
- » 5 elegant painted Wood & Resin Finishes that coordinate beautifully with natural elements and earthy textures in a room.
- » A comprehensive range of diameters and styles.
- » 1 ½" Diameter Metal Styles » Modern, Clean Deco, Transitional Luxe.
- » 1 ¾" Diameter Metal, Wood & Resin Styles » Modern, Today's Traditional, Heritage Classics.
- » 2 ¼" Diameter Wood & Resin Styles » Today's Traditional, Heritage Classics.
- » Ships within 24 hours!

Style
Modern



Explore the Style »



1 1/8" Modern Finial Collection new

Inspiring a Modern lifestyle, the updated 1 1/8" Modern Collection is defined by clean lines, contemporary materials and sophisticated silhouettes designed with an approachable appeal. 1 1/8" Finials require a cuff / finial adapter to work with 1 1/8" Metal Traverse. See pages 82 - 89.

1 1/8" Modern Finials are available in 6 Quick Ship Metal Finishes »



Brushed Nickel
BN



Satin Gold
SG



Rose Gold
RGD



Brushed Bronze
BZ



Charcoal Zinc
CZ



Matte Black
MK

1 1/8" Modern Finial Collection new



new **Emery End Cap**
 QS118EMEC
 3/4" L x 1 1/4" W
 Metal, Brushed Nickel



new **Evan End Cap**
 QS118EVEC
 3/4" L x 1 3/4" W
 Metal, Satin Gold



new **Ryder - Crystal**
 QS118RYFI
 1 3/4" L x 1 3/4" W
 Metal / Crystal, Rose Gold



new **Reese - Crystal**
 QS118REFI
 2 3/4" L x 2 1/2" W
 Crystal, Metal Pole shown
 in Charcoal Zinc



Knox - Crystal
 QS118KNFI
 1 1/4" L x 2 5/8" W
 Crystal, Metal Pole shown
 in Brushed Bronze



Ella
 QS118ELAFI
 1 5/8" L x 1 5/8" W
 Metal, Brushed Nickel



new **London - Crystal**
 QS118LOFI
 1 7/8" L x 3" W
 Metal / Crystal, Matte Black



Elm
 QS118EMFI
 1 1/8" L x 2" W
 Metal, Charcoal Zinc



Elm - Smoke Glass
 QS118EMFIGL
 1 1/8" L x 2" W
 Metal / Glass, Satin Gold



Lex
 QS118LXFI
 1 7/8" L x 2" W
 Metal, Satin Gold



Cole
 QS118COFI
 3 3/4" L x 1 1/2" W
 Metal, Matte Black



Modern Finish
 Highlight »
**Satin Gold
 & Matte Black**



Finial Accessories

Dress up your 1 1/8" finial or pole with our Mix & Match accessories. See page 112.



new **1 1/8" Transitional Cuff / Finial Adapter**
 QS118CUFF
 3/4" L x 1 1/4" W
 Metal, Charcoal Zinc on Satin Gold pole



Elm - Smoke Glass Finial
 in Satin Gold finish with
 Transitional Cuff in Charcoal
 Zinc finish



new **1 1/8" Deco Cuff / Finial Adapter**
 QS118DECUFF
 3/4" L x 1 3/8" W
 Metal, Brushed Bronze



Knox - Crystal Finial
 with Deco Cuff in Brushed
 Bronze finish

Style Meets Function

1 1/8" Finials require a cuff / finial adapter to work with 1 1/8" Metal Traverse. See pages 82 - 89.

Ella Finial with Finial Adapter
 in Brushed Nickel finish

Style
Clean
Deco



Neve - Crystal

Metal / Crystal,
Matte Black

1 1/8" Clean Deco Finial Collection new

Mid-century design finds bold new expression in the Clean Deco Collection, featuring 8 new finial designs and a Deco Cuff / Finial Adapter. 1 1/8" Finials require a cuff / finial adapter to work with 1 1/8" Metal Traverse. See pages 82 - 89.

Explore the Style »



1 1/8" Clean Deco Finials are available in 6 Quick Ship Metal Finishes »



Brushed Nickel
BN



Satin Gold
SG



Rose Gold
RGD



Brushed Bronze
BZ



Charcoal Zinc
CZ



Matte Black
MK

1 1/8" Clean Deco Finial Collection new



new Deco End Cap
QS118DEEC
3/4" L x 1 3/8" W
Metal, Rose Gold



new Zane End Cap
QS118ZAEC
5/8" L x 2 3/8" W
Metal, Matte Black

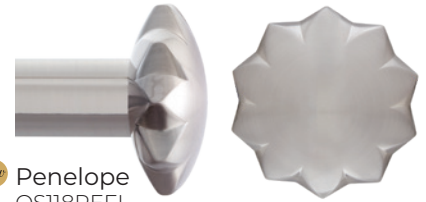

new Penelope
QS118PEFI
1 1/8" L x 2 3/4" W
Metal, Brushed Nickel

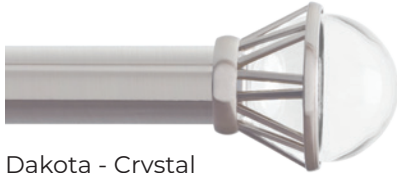

new Dakota - Crystal
QS118DAFI
2 3/4" L x 2 1/2" W
Metal / Crystal, Brushed Nickel



new Neve - Crystal
QS118NVFI
2 1/2" L x 2" W
Metal / Crystal, Satin Gold



new Wren
QS118WRFI
2" L x 1 7/8" W
Metal, Brushed Bronze



new Viktor
QS118VIFI
1 1/2" L x 2 3/4" W
Metal / Acrylic, Satin Gold

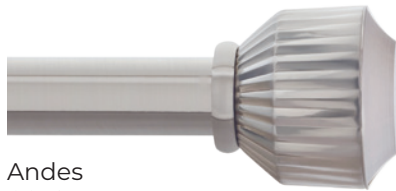

new Andes
QS118ANFI
2 1/2" L x 2 5/8" W
Metal, Brushed Nickel



new Wright - Crystal
QS118WIFI
2 1/2" L x 2 3/4" W
Metal / Crystal, Charcoal Zinc



Clean Deco
Finish Highlight »
Brushed Nickel



1 1/8" Transitional Luxe Finial Collection new

Luxe, sophisticated and of the moment, create endlessly elegant drapery hardware designs with a thoughtfully curated mix of classic and modern details. 1 1/8" Finials require a cuff / finial adapter to work with 1 1/8" Metal Traverse. See pages 82 - 89.

Style
Transitional
Luxe



Nora
QS118NOFI
2 1/8" L x 2 3/8" W
Metal, Brushed Bronze



Nora - Mercury Glass
QS118NOFIGL
2 1/8" L x 2 3/8" W
Metal / Glass, Charcoal Zinc



Transitional Luxe
Finish Highlight »
Charcoal Zinc



Explore the Style »



Mix & Match

Create an even more *customized* design »



Need Some Glamour?

Pair a 1 1/8" Crystal Band with your favorite 1 1/8" finial design. Place 1-2 anywhere along the pole for the ultimate customization.

Transitional Style

Use a 1 1/8" or 1 3/8" Transitional Cuff / Finial Adapter to adapt your finials to the metal traverse systems, or use the cuffs to mix & match finishes and customize your design.

Clean Deco Style

Upgrade your finial with the 1 1/8" Deco Cuff / Finial Adapter to create deco-inspired style, or to adapt your finials to the metal traverse systems.

How To Add Your Cuff / Finial Adapter »



1 Select your Cuff style and finish - Mix & Match for the ultimate customization.



2 Place Cuff onto metal pole and tighten set screw with Allen Wrench.



3 Install finials by screwing into the Cuff / Finial Adapter.

1 1/8" Modern Metal Brackets *new*

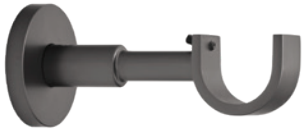

new Declan Single
QS118DESBK
2" DIA backplate, 3 1/2" return
Metal, Charcoal Zinc



new Declan 6" Single
QS118DES6BK
2" DIA backplate, 6" return
Metal, Charcoal Zinc



new Declan Double
QS118DEDBK
2" DIA backplate, 6 1/2" front return and
3 1/2" back return
Metal, Charcoal Zinc



new Axel Single
QS118AXSBK
2" DIA backplate, 3 1/2" return
Metal, Charcoal Zinc



new Axel 6" Single
QS118AXS6BK
2" DIA backplate, 6" return
Metal, Charcoal Zinc



new Axel Double
QS118AXDBK
2" DIA backplate, 6 1/2" front return and
3 1/2" back return
Metal, Charcoal Zinc



new Aiden Single
QS118AESBK
2" DIA backplate, 3 1/2" return,
use with Caden C-Rings
Metal, Charcoal Zinc



new Aiden Double
QS118AEDBK
2" DIA backplate, 6 1/2" front return and
3 1/2" back return, 3/16" clearance above
backplate, use with Caden C-Rings
Metal, Charcoal Zinc



new Inside Mount
QS118IMBK
1 13/16" DIA backplate x 1 1/4" D,
3/16" thick backplate per bracket
Metal, Charcoal Zinc

Finish »
Charcoal Zinc



1 1/8" Modern Metal Brackets are available in 6 Quick Ship Metal Finishes »



Brushed Nickel
BN



Satin Gold
SG



Rose Gold
RGD



Brushed Bronze
BZ



Charcoal Zinc
CZ



Matte Black
MK

1 1/8" Metal Pole new

1 1/8" metal poles are sold in 2' increments. 2' minimum. Poles will be cut to specified lengths; fall off will not be saved or shipped. Maximum continuous length up to 12' on BN, CZ and MK finishes; up to 8' on SG, RGD and BZ finishes. 1 1/8" metal poles are supplied with plastic inserts to attach the finials.



new Metal Pole
QS118ME
Metal, Brushed Nickel

Style Meets Function

1 1/8" Finials require a cuff / finial adapter to work with 1 1/8" Metal Traverse. See pages 82 - 89.

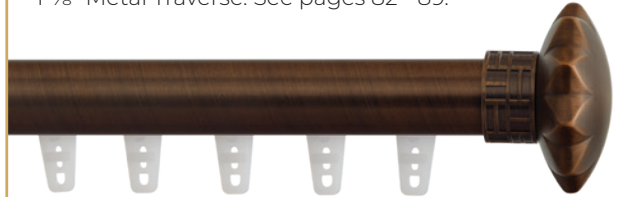

Penelope Finial with Deco Cuff / Finial Adapter in Brushed Bronze finish

1 1/8" Metal Rings new

Ring Drop indicates distance from bottom of pole to bottom of ring.



new Austin Ring
QS118AURI
1 1/4" ID, 1 5/8" OD, 3/4" drop
Metal, Brushed Nickel



new Caden C-Ring
QS118CACRI
1 1/4" ID, 1 5/8" OD, 3/4" drop,
use with Aiden brackets
Metal, Brushed Nickel

Finish »
Brushed
Nickel



1 1/8" Metal Accessories



Metal Batons
36" QSME36WAND
48" QSME48WAND
60" QSME60WAND
3/8" DIA, Metal,
Brushed Nickel



new Handicap Metal Batons
48" QSME48HWAND
60" QSME60HWAND
4" Loop, ADA Compliant,
Metal, Brushed Nickel
Finishes Available: BN, BZ & MK



new Hinged Elbow
QS118MEL
1 1/8" DIA, 2 7/8" overall length,
1 3/4" L each side when bent
Metal, Brushed Nickel



Clear Acrylic Batons
36" AC36WAND
48" AC48WAND
60" AC60WAND
1/2" DIA, Acrylic



new Handicap Clear Acrylic Batons
48" AC48HWAND
60" AC60HWAND
72" AC72HWAND
4" Loop, ADA Compliant, Acrylic



new Pole Splice
PSME118403
4 5/8" L, must be ordered separately

1 1/8" Metal Poles, Rings & Accessories are available in 6 Quick Ship Metal Finishes »



Brushed Nickel
BN



Satin Gold
SG



Rose Gold
RGD



Brushed Bronze
BZ



Charcoal Zinc
CZ



Matte Black
MK

Modern Holdback Medallions new

Fit modern holdback stems; sold separately. Sold in pairs.



new **Hadley**
QSHAHB
3 1/2" DIA, 1" TH
Metal, Matte Black



new **Parker**
QSPAHB
3 1/4" square, 1" TH
Metal, Brushed Nickel

Modern Holdback Stems new

Must order separately. Sold in pairs. Projection indicates distance from wall to back of medallion.
Metal, Brushed Nickel

Base: 2 3/16" DIA, Stem: 1/2" DIA, specify 2", 4" or 6" PROJ:



QSMHBSTEM2
2" PROJ



QSMHBSTEM4
4" PROJ



QSMHBSTEM6
6" PROJ

Reduce sidelight with the clean, modern look of 1 1/8" French Returns »

Our NEW curved French Return brackets with stylish Round or Square mounting plates and return bands allow panels to wrap around securely to the wall, creating a more refined elegance.

Available in any of our 35 Portfolio Hand Painted Finishes or PTH Perfect Match™.

See pages 22 - 23.



1 1/8" Modern Holdbacks are available in 6 Quick Ship Metal Finishes »



Brushed Nickel
BN



Satin Gold
SG



Rose Gold
RGD



Brushed Bronze
BZ



Charcoal Zinc
CZ



Matte Black
MK

Style
Modern



Quinn
Metal, Satin Gold

1 3/8" Modern Finial Collection new

Inspiring a Modern lifestyle, the updated 1 3/8" Modern Collection is defined by clean lines, contemporary materials and sophisticated silhouettes designed with an approachable appeal.

1 3/8" Modern Finials are available in 6 Quick Ship Metal Finishes »



Brushed Nickel
BN



Satin Gold
SG



Rose Gold
RGD



Brushed Bronze
BZ



Charcoal Zinc
CZ



Matte Black
MK

1 3/8" Modern Finial Collection new



new **Ainsley End Cap**
 QSI38AIEC
 3/4" L x 1 1/2" W
 Metal, Satin Gold



new **Asher End Cap**
 QSI38ASEC
 1" L x 2 1/4" W
 Metal, Brushed Bronze



new **Quinn**
 QSI38QUFI
 1 3/4" L x 2 1/4" W
 Metal, Matte Black



new **Adair**
 QSI38ADFI
 3 3/8" L x 3" W
 Metal, Charcoal Zinc

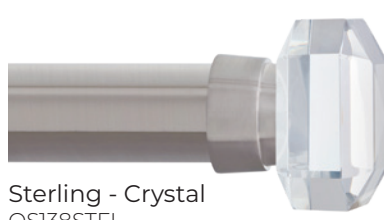

new **Sterling - Crystal**
 QSI38STFI
 2 1/4" L x 3" W
 Metal / Crystal, Brushed Nickel

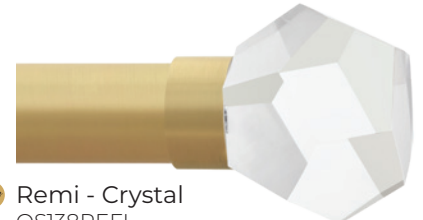

new **Remi - Crystal**
 QSI38REFI
 3 1/4" L x 3" W
 Metal / Crystal, Satin Gold



new **London - Crystal**
 QSI38LOFI
 2 5/8" L x 3 3/8" W
 Metal / Crystal, Matte Black

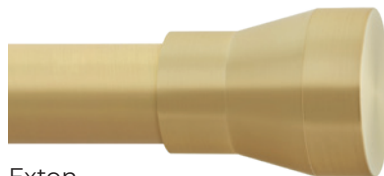

new **Exton**
 QSI38EXFI
 2 3/4" L x 2 1/4" W
 Metal, Satin Gold



new **Zara**
 QSI38ZAFI
 2 1/2" L x 3 1/2" W
 Metal / Clear Acrylic,
 Charcoal Zinc



new **Cohen**
 QSI38COFI
 1 7/8" L x 3 3/8" W
 Metal / Clear Acrylic,
 Rose Gold



Modern Finish
 Highlight »
**Satin Gold
 & Matte Black**



Explore the Style »

Style Meets Function

1 3/8" Finials work with 1 3/8" Metal Traverse, including our new R-TEC Automation® Traverse Systems. See pages 60 - 67 and 90 - 97.

*1 3/8" Modern Finials are designed to attach directly to the Metal Traverse rod with a set screw. Transitional Cuff / Finial Adapter is not required.



Adair Finial in Brushed Nickel finish on **R-TEC AUTOMATION®**



Designer
Expertise

**Our NEW Modern Metal Bracket designs
provide the ultimate modern style »**

1 3/8" Modern Metal Brackets *new*

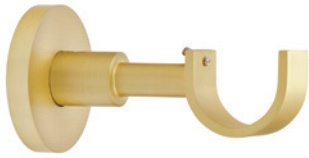

new Grant Single
QSI38GASBK
2 1/2" DIA backplate, 3 1/2" return
Metal, Satin Gold



new Grant 6" Single
QSI38GAS6BK
2 1/2" DIA backplate, 6" return
Metal, Satin Gold



new Grant Double
QSI38GADBK
2 1/2" DIA backplate, 6 1/2" front return and
3 1/2" back return
Metal, Satin Gold



new Gage Single
QSI38GGSBK
2 1/2" DIA backplate, 3 1/2" return
Metal, Satin Gold



new Gage 6" Single
QSI38GGS6BK
2 1/2" DIA backplate, 6" return
Metal, Satin Gold



new Gage Double
QSI38GGDBK
2 1/2" DIA backplate, 6 1/2" front return and
3 1/2" back return
Metal, Satin Gold



new Talon Single
QSI38TASBK
2 1/2" DIA backplate, 3 1/2" return,
use with Calla C-Rings
Metal, Satin Gold



new Talon Double
QSI38TADBK
2 1/2" DIA backplate, 6 1/2" front return and
3 1/2" back return, 3/8" clearance above
backplate, use with Calla C-Rings
Metal, Satin Gold



new Inside Mount
QSI38IMBK
2" DIA backplate x 1 9/16" D,
1/4" thick backplate per bracket
Metal, Satin Gold

Finish »
Satin Gold



1 3/8" Modern Metal Brackets are available in 6 Quick Ship Metal Finishes »



Brushed Nickel
BN



Satin Gold
SG



Rose Gold
RGD



Brushed Bronze
BZ



Charcoal Zinc
CZ



Matte Black
MK

1 3/8" Metal Pole | 1 3/8" Acrylic Pole

1 3/8" metal and acrylic poles are sold in 2' increments. 2' minimum. Poles will be cut to specified lengths; fall off will not be saved or shipped. Maximum continuous length up to 12' on BN, CZ and MK metal finishes; up to 8' on SG, RGD and BZ metal finishes. 1 3/8" metal poles are supplied with plastic inserts to attach wood & resin finials, if desired. Acrylic poles only work with the 1 3/8" Modern Finial Collection. Maximum continuous length up to 12' on acrylic poles; cannot be spliced.

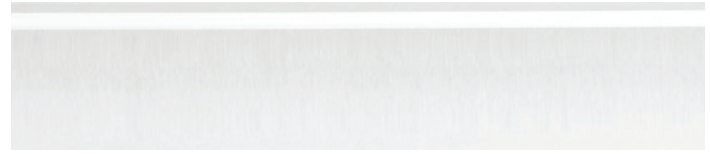
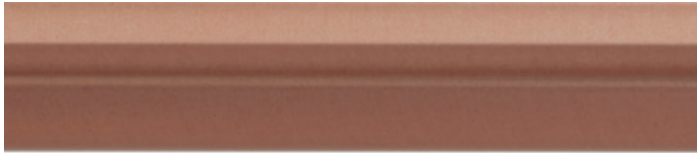

Metal Pole
QS138ME

Metal, Rose Gold

Acrylic Pole
QS138AC

Clear Acrylic

Style Meets Function

1 3/8" Modern Finials work with 1 3/8" **RTEC** AUTOMATION™ Metal Traverse on pages 60 - 67 and 1 3/8" Metal Baton Draw Traverse on pages 90 - 97.



1 3/8" Metal Rings new

Ring Drop indicates distance from bottom of pole to bottom of ring.



new Rowan Ring
QS138RORI

2" ID, 2 3/8" OD, 3/4" drop
Metal, Rose Gold



new Calla C-Ring
QS138CLCRI

2" ID, 2 3/8" OD, 3/4" drop,
use with Talon brackets
Metal, Rose Gold

Finish »
Rose Gold



1 3/8" Metal Accessories



Metal Batons
36" QSME36WAND
48" QSME48WAND
60" QSME60WAND
3/8" DIA, Metal,
Rose Gold



new **Handicap Metal Batons**
48" QSME48HWAND
60" QSME60HWAND
4" Loop, ADA Compliant,
Metal, Brushed Nickel
Finishes Available: BN, BZ & MK



new Hinged Elbow
QS138MEL

1 3/8" DIA, 2 7/8" overall length, 2" L
each side when bent
Metal, Rose Gold



Clear Acrylic Batons
36" AC36WAND
48" AC48WAND
60" AC60WAND
1/2" DIA, Acrylic



new **Handicap Clear Acrylic Batons**
48" AC48HWAND
60" AC60HWAND
72" AC72HWAND
4" Loop, ADA Compliant, Acrylic



new Pole Splice
PSME138403

4 3/4" L, must be ordered separately

1 3/8" Metal Poles, Rings & Accessories are available in 6 Quick Ship Metal Finishes »



Brushed Nickel
BN



Satin Gold
SG



Rose Gold
RGD



Brushed Bronze
BZ



Charcoal Zinc
CZ



Matte Black
MK

Modern Holdback Medallions new

Fit modern holdback stems; sold separately. Sold in pairs.



new **Hadley**
QSHAHB
3 1/2" DIA, 1" TH
Metal, Matte Black



new **Parker**
QSPAHB
3 1/4" square, 1" TH
Metal, Brushed Nickel

Modern Holdback Stems new

Must order separately. Sold in pairs. Projection indicates distance from wall to back of medallion.
Metal, Brushed Nickel

Base: 2 3/16" DIA, Stem: 1/2" DIA, specify 2", 4" or 6" PROJ:



QSMHBSTEM2
2" PROJ



QSMHBSTEM4
4" PROJ



QSMHBSTEM6
6" PROJ

Reduce sidelight with the clean, modern look of 1 3/8" French Returns »

Our NEW curved French Return brackets with stylish Round or Square mounting plates and return bands allow panels to wrap around securely to the wall, creating a more refined elegance.

Available in any of our 35 Portfolio Hand Painted Finishes or PTH Perfect Match™.

See pages 30 - 31.



1 3/8" Modern Holdbacks are available in 6 Quick Ship Metal Finishes »



Brushed Nickel
BN



Satin Gold
SG



Rose Gold
RGD



Brushed Bronze
BZ



Charcoal Zinc
CZ



Matte Black
MK

Style
Today's
Traditional



1 3/8" Today's Traditional Finial Collection

Purposefully designed with a minimalist elegance that reflects a modern interpretation of classic style with an uncompromising attention to every detail and material, the Today's Traditional Collection elevates timeless window design.

Explore the Style »



1 3/8" Today's Traditional Finial Collection

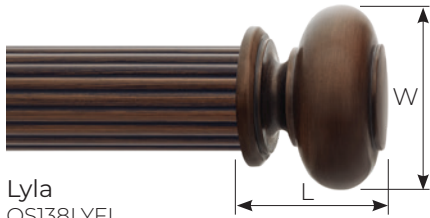

Lyla
QS138LYFI
2 5/8" L x 2 3/4" W
Resin, Walnut



new Aubrie End Cap
QS138AUFC
3/4" L x 2 1/4" W
Resin, Platinum



Rose - Crystal
QS138ROFI
2 1/2" L x 2 3/4" W
Resin / Crystal, Antique Brass



Bradford
QS138BRFI
3 1/4" L x 2 3/4" W
Resin, Platinum



new Everette
QS138EVFI
2 7/8" L x 3 1/4" W [2 1/2" square]
Resin, Walnut



new Leo
QS138LEFI
3 1/2" L x 2 3/4" W
Resin, Oil Rubbed Bronze



Lillian
QS138LIFI
4" L x 3 3/8" W
Resin, Antique Brass



Lillian - Mercury
Glass
QS138LIFIGL
4" L x 3 3/8" W
Resin / Glass, Oil Rubbed Bronze



June
QS138JUFI
2 3/4" L x 2 5/8" W
Resin, Platinum



Today's Traditional
Finish Highlight »
Walnut



1 3/8" Today's Traditional Finials are available in 5 Quick Ship Wood & Resin Finishes »



Platinum
PL



Antique Brass
AB



Rose Gold
RG



Walnut
WAL



Oil Rubbed Bronze
ORB

Style
Heritage
Classics



Lane
Resin, Rose Gold

1 3/8" Heritage Classics Finial Collection

Our Heritage Classics Style may be a new category, but this collection features new finial designs as well as Paris Texas Hardware classics that have been favorites throughout the years. With ornate details and Old World design, these are sure to make a big statement for your windows.

Explore the Style »



Orders ship within 24 hours

Quick Ship: 1 3/8"

1 3/8" Heritage Classics Finial Collection



Lowell End Cap
QS138LOEC
1" L x 2" W
Resin, Rose Gold



Harper
QS138HAFI
3" L x 2 3/4" W
Resin, Antique Brass



Lane
QS138LAFI
3 5/8" L x 3 1/2" W
Resin, Platinum



Explore the Style »



Heritage Classics
Finish Highlight »

Rose Gold & Platinum



1 3/8" Heritage Classics Finials are available in 5 Quick Ship Wood & Resin Finishes »



Platinum
PL



Antique Brass
AB



Rose Gold
RG



Walnut
WAL



Oil Rubbed Bronze
ORB



Designer
Expertise

Quick Ship Wood & Resin
Finishes work beautifully
with natural materials and
earthy textures »

1 3/8" Brackets



William Single
QS138WISBK

1" W x 3 7/16" H backplate, 3 5/8" return
Resin, Platinum



William 6 5/8" Single
QS138WIS6BK

1" W x 3 7/16" H backplate, 6 5/8" return
Resin, Platinum



William Double
QS138WIDBK

1" W x 3 7/16" H backplate, 6 1/2" front
return and 3 1/4" back return
Resin, Platinum

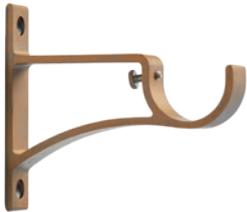

Winston Single
QS138WSSBK

3/4" W x 3 3/4" H backplate, 3 1/2" return
Metal, Rose Gold



Winston 6" Single
QS138WSS6BK

3/4" W x 3 3/4" H backplate, 6" return
Metal, Rose Gold



Winston Double
QS138WSDBK

3/4" W x 3 3/4" H backplate, 6" front
return and 3" back return
Metal, Rose Gold



new Adjustable Single Bracket
QSBKT138

1" W x 3 1/4" H backplate,
adjustable 3 1/2" - 5" return
Metal, Rose Gold



Front view when installed.

Inside Mount (sold in pairs)
QS138MIBK

1" W x 1 1/4" H x 1 7/8" D, 1/4" thick
backplate per bracket
Metal, Rose Gold



Ceiling Single
QS138MCMBK

2 3/4" H, 2" DIA backplate, 2 5/8" drop
Metal, Rose Gold

Finishes »
Platinum &
Rose Gold



1 3/8" Brackets are available in 5 Quick Ship Wood & Resin Finishes »



Platinum
PL



Antique Brass
AB



Rose Gold
RG



Walnut
WAL



Oil Rubbed Bronze
ORB

1 3/8" Wood Poles

1 3/8" wood poles are sold in 2' increments. 2' minimum. Poles will be cut to specified lengths; fall off will not be saved or shipped. Maximum continuous length up to 12'.

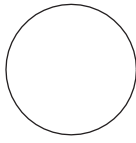

Smooth Wood Pole
QSI38SM
Wood, Platinum

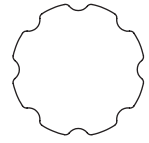

new Grooved / Fluted Wood Pole
QSI38GR
Wood, Platinum

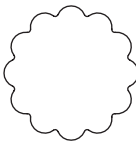

Reeded Wood Pole
QSI38RE
Wood, Platinum

Style Meets Function

Motorized Traverse	
• RECO AUTOMATION™	68
• Somfy®	78
Manual Traverse	
• HD Corded or Baton	98

1 3/8" Rings



Wood Ring
QSI38WRI
1/2" W, 1 3/4" ID, 2 5/8" OD, 3/4" drop
Wood, Platinum



Metal Ring
QSI38MRI
1 3/4" ID, 2 1/4" OD, 5/8" drop
Metal, Platinum



1 3/8" Accessories



new Fiberglass Batons
36" QSRE36WAND
48" QSRE48WAND
60" QSRE60WAND
3/8" DIA, Fiberglass, Platinum



Clear Acrylic Batons
36" AC36WAND
48" AC48WAND
60" AC60WAND
1/2" DIA, Acrylic



new Handicap Clear Acrylic Batons
48" AC48HWAND
60" AC60HWAND
72" AC72HWAND
4" Loop, ADA Compliant, Acrylic



Hinged Elbow
QSI38REL
1 5/8" DIA, 3 7/8" OL,
2" L each side when bent
Resin, Platinum

1 3/8" Poles, Rings and Accessories are available in 5 Quick Ship Wood & Resin Finishes »



Platinum
PL



Antique Brass
AB



Rose Gold
RC



Walnut
WAL



Oil Rubbed Bronze
ORB



Designer
Expertise

Use finishes, fabrics and textures
to inspire your next project »

Transitional Holdback Medallions

Fit modern or transitional resin holdback stems; sold separately. Sold in pairs.

Brooks
QSBHRB
4" DIA, 1 3/4" TH
Resin, Rose Gold



Trudy
QSTRHB
4 3/4" DIA, 3/4" TH
Resin, Walnut



Miranda
QSMIHB
5" DIA, 1 1/2" TH
Resin, Platinum



Transitional Holdback Stems new

Must order separately. Sold in pairs. Projection indicates distance from wall to back of medallion.
Resin, Walnut

Base: 3" DIA, Stem: 5/8" DIA,
specify 2", 4" or 6" PROJ:



QSTHBSTEM2
2" PROJ



QSTHBSTEM4
4" PROJ



QSTHBSTEM6
6" PROJ

1 3/8" Transitional Holdbacks are available in 5 Quick Ship Wood & Resin Finishes »



Platinum
PL



Antique Brass
AB



Rose Gold
RG



Walnut
WAL



Oil Rubbed Bronze
ORB



Style
Today's
Traditional



Stella

Resin, Oil
Rubbed Bronze

2 1/4" Today's Traditional Finial Collection

Purposefully designed with a minimalist elegance that reflects a modern interpretation of classic style with an uncompromising attention to every detail and material, the Today's Traditional Collection elevates timeless window design.

2 1/4" Today's Traditional Finials are available in 5 Quick Ship Wood & Resin Finishes »



Platinum
PL



Antique Brass
AB



Rose Gold
RG



Walnut
WAL



Oil Rubbed Bronze
ORB

2 1/4" Today's Traditional Finial Collection

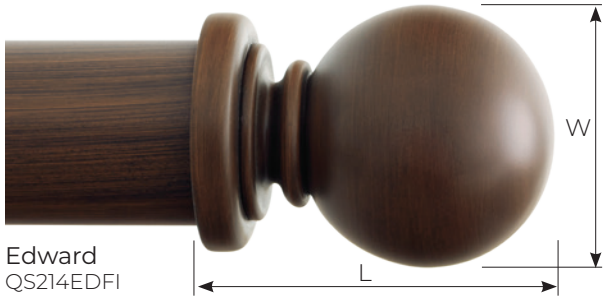

Edward
QS214EDFI
4 1/4" L x 3 1/4" W
Resin, Walnut



new Aspen
QS214APFI
4 1/2" L x 4 1/2" W
Resin, Antique Brass



Hazel - Crystal
QS214HZFI
2 5/8" L x 3 3/8" W
Resin / Crystal, Platinum



new Amelie
QS214AMFI
2" L x 3 1/4" W
Resin, Oil Rubbed Bronze



Stella
QS214STFI
2 1/2" L x 3 1/4" W
Resin, Rose Gold



Sidney
QS214SIFI
3 1/8" L x 4 1/8" W [3" square]
Resin, Walnut



Explore the Style »



Today's Traditional
Finish Highlight »
Oil Rubbed Bronze



Style
Heritage
Classics

Explore the Style »



2 1/4" Heritage Classics Finial Collection

Our Heritage Classics Style may be a new category, but this collection features new finial designs as well as Paris Texas Hardware classics that have been favorites throughout the years. With ornate details and Old World design, these are sure to make a big statement for your windows.

2 1/4" Heritage Classics Finials are available in 5 Quick Ship Wood & Resin Finishes »



Platinum
PL



Antique Brass
AB



Rose Gold
RC



Walnut
WAL



Oil Rubbed Bronze
ORB

2 1/4" Heritage Classics Finial Collection



new Margot End Cap
QS214MAEC
3/4" L x 3" W
Resin, Antique Brass



Oliver
QS214OLFI
3 5/8" L x 3 7/8" W
Resin, Platinum



Adelaide
QS214ADFI
5" L x 3 1/2" W
Resin, Rose Gold



new Farrin - Mercury Glass
QS214FAFI
4 1/2" L x 4 7/8" W
Metal / Glass, Oil Rubbed Bronze



Adelaide - Mercury Glass
QS214ADFIGL
5" L x 3 1/2" W
Resin / Glass, Walnut



Fiona
QS214FIFI
4" L x 5" W
Resin, Antique Brass



Heritage Classics
Finish Highlight »
Antique Brass





Aspen

Resin, Walnut

2 1/4" Metal Brackets

Return indicates distance from wall to center of pole.



Harlan Single
QS214HASBK

3 3/4" H x 3/4" W backplate, 4" return
Metal, Antique Brass



Harlan 6" Single
QS214HAS6BK

3 3/4" H x 3/4" W backplate, 6" return
Metal, Antique Brass



Harlan Double Bracket
QS214HADBK

3 3/4" H x 3/4" W backplate, 6" front return and 2 1/2" back return, front cradle holds 2 1/4" DIA pole, back cradle holds 1 3/8" DIA pole
Metal, Antique Brass



Front view when installed.

Inside Mount (sold in pairs)
QS214MIBK

1" W x 1 5/8" H x 2 7/8" D, 1/4" thick
backplate per bracket
Metal, Antique Brass



Ceiling Single
QS214MCMBK

3 3/4" H x 3 1/4" D, 3 1/2" drop
Metal, Antique Brass

Finish »
Antique Brass





Finish »
Walnut



2 1/4" Wood & Resin Brackets

Return indicates distance from wall to center of pole.



William Single
QS214WISBK
1" W x 3 3/4" H backplate, 4" return
Resin, Platinum



William 7" Single
QS214WIS6BK
1" W x 3 3/4" H backplate, 7" return
Resin, Platinum



William Double
QS214WIDBK
1" W x 3 3/4" H backplate, 6 3/4" front return and 3 1/4" back return, front cradle holds 2 1/4" DIA pole, back cradle holds 1 3/8" DIA pole
Resin, Platinum

Finish »
Platinum



2 1/4" Brackets are available in 5 Quick Ship Wood & Resin Finishes »



Platinum
PL



Antique Brass
AB



Rose Gold
RG



Walnut
WAL



Oil Rubbed Bronze
ORB

2 1/4" Wood Poles

2 1/4" wood poles are sold in 2' increments. 2' minimum. Poles will be cut to specified lengths; fall off will not be saved or shipped. Maximum continuous length up to 12'.

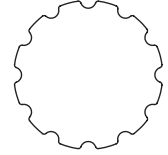
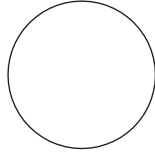

Smooth Wood Pole
QS214SM

Wood, Rose Gold

new

Grooved / Fluted Wood Pole
QS214GR

Wood, Rose Gold

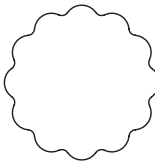

Reeded Wood Pole
QS214RE

Wood, Rose Gold

Style Meets Function

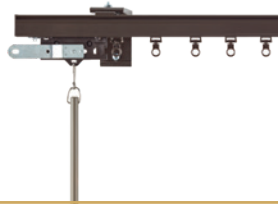

Motorized Traverse

- **RECO** AUTOMATION™ 68
- Somfy® 78

Manual Traverse

- HD Corded or Baton 98

2 1/4" Rings

Ring Drop indicates distance from bottom of pole to bottom of ring.



Wood Ring
QS214WRI

2 5/8" ID, 3 5/8" OD, 7/8" drop
Wood, Rose Gold

Metal Ring
QS214MRI

2 1/2" ID, 3" OD, 1/2" drop
Metal, Rose Gold

Finish »
Rose Gold



2 1/4" Accessories



new

Fiberglass Batons

36" QSRE36WAND

48" QSRE48WAND

60" QSRE60WAND

3/8" DIA, Fiberglass, Rose Gold



Clear Acrylic Batons

36" AC36WAND

48" AC48WAND

60" AC60WAND

1/2" DIA, Acrylic



Hinged Elbow
QS214REL

2 3/8" DIA, 5 1/8" OL, 2 9/16" L each
side when bent
Resin, Rose Gold



new

Handicap Clear Acrylic Batons

48" AC48HWAND

60" AC60HWAND

72" AC72HWAND

4" Loop, ADA Compliant, Acrylic

Transitional Holdback Medallions

Fit transitional resin holdback stems; sold separately. Sold in pairs.

Brooks

QSBRHB

4" DIA, 1 1/4" TH
Resin, Rose Gold



Trudy

QSTRHB

4 3/4" DIA, 3/4" TH
Resin, Walnut



Miranda

QSMIHB

5" DIA, 1 1/2" TH
Resin, Platinum



Modern Holdback Medallions

Fit transitional resin holdback stems; sold separately. Sold in pairs.

Hadley

new QSHAHB

3 1/2" DIA, 1" TH
Metal, Platinum



new **Parker**

QSPAHB

3 1/4" square, 1" TH
Metal, Oil Rubbed Bronze

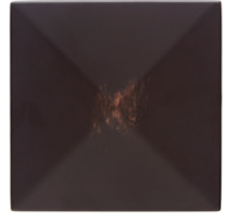

Blake - Mercury Glass

QSBKHB

3" DIA, 2 3/8" TH
Metal / Glass, Rose Gold



Transitional Holdback Stems *new*

Must order separately. Sold in pairs. Projection indicates distance from wall to back of medallion.
Resin, Walnut

Base: 3" DIA, Stem: 5/8" DIA,
specify 2", 4" or 6" PROJ:



QSTHBSTEM2
2" PROJ



QSTHBSTEM4
4" PROJ



QSTHBSTEM6
6" PROJ

2 1/4" Poles, Rings, Accessories & Holdbacks are available in 5 Quick Ship Wood & Resin Finishes »



Platinum
PL



Antique Brass
AB



Rose Gold
RG



Walnut
WAL



Oil Rubbed Bronze
ORB

Sales Tools new

Inspire your clients with professional sales tools designed to showcase Paris Texas Hardware™ and drive revenue for your business. Select from Wall Displays and Table Top Displays with the newest finial designs and finishes.



new Portfolio Metal Wall Display Board
 PTH22POMWDB
 24" H x 24" W x 6 ¼" Deep
 Wall Mount



new Quick Ship Metal Wall Display Board
 PTH22QSMWDB
 24" H x 24" W x 6 ¼" Deep
 Wall Mount



new Portfolio Wood & Resin Wall Display Board
 PTH22POWRDB
 24" H x 24" W x 6" Deep
 Wall Mount



new Quick Ship Wood & Resin Wall Display Board
 PTH22QSWRDB
 24" H x 24" W x 6" Deep
 Wall Mount

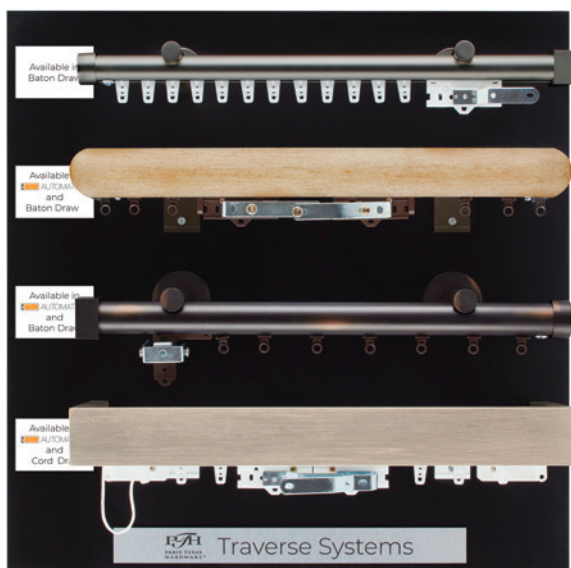

new Traverse Wall Display Board
PTH22TDB
24" H x 24" W x 6" Deep
Wall Mount



new R-TEC Automation® Display Kit (case & kit*) RTMDK
30 1/4" H x 26 3/4" W x 8" Deep (case)
*R-TEC Smart Controls not included; see page 71 for our selection.

Order Modules Separately:

- new** R-TEC Automation® Motorized Metal Module RTMDK/FMH
- new** R-TEC Automation® Track Module with Fascia* RTMDK/TRACK
*1 3/8" fascia included for reference only; see page 74 for a full list of fascia styles available in this collection, and choose from any of our 35 Portfolio Hand Painted Finishes, 5 Quick Ship Wood & Resin Finishes or your own PTH Perfect Match™ Finish.
- new** Slim Drapery Motor + Battery Kit* RTMLDKIT
*Works with motorized metal and track modules above.



new Portfolio Table Top Display
PTH22TTPO
12" H x 20" W x 8" Deep



new Quick Ship Table Top Display
PTH22TTQS
8 5/8" H x 20" W x 8" Deep

General Info

Portfolio Finishes	
AM	Amulet
AND	Andiron
AG	Antique Gold
AGL	Antique Gold Leaf
AB	Art Bronze
BW	Barnwood
BL	Black
BLU	Blush
BP	Bronzed Pewter
CO	Concrete
COU	Couture
DC	Dark Chocolate
FL	Firelight
GOS	Gossamer
GRE	Greige
HA	Halo
JA	Java
LIN	Linen
LU	Luminous
MA	Manor
MK	Mink
ML	Moonlight
MYS	Mystic
NAB	New Age Bronze
PAT	Patina
SH	Shimmer
SM	Silver Maple
SPW	Spicewood
SPG	Spun Gold
STA	Stardust
ST	Starlet
TTM	Titanium
TRU	Truffle
URB	Urban Bronze
WH	White
Quick Ship Wood & Resin 1 3/8" and 2 1/4" Finishes	
AB	Antique Brass
ORB	Oil Rubbed Bronze
PL	Platinum
RG	Rose Gold
WAL	Walnut
Quick Ship Metal 1 1/8" and 1 3/8" Finishes	
BZ	Brushed Bronze
BN	Brushed Nickel
CZ	Charcoal Zinc
MK	Matte Black
RGD	Rose Gold
SG	Satin Gold
PTH Perfect Match™ Finishes	
PPMEF	Eggshell Sheen Level
PPMHGF	High-Gloss Sheen Level
PPMGLITTER	Glitter Highlights
PPMGOLD	Gold Highlights
PPMROSEGOLD	Rose Gold Highlights
PPMSILVER	Silver Highlights

Finishes

Finishes with antiquing, dusting or glazing will vary from product to product depending on the level of detail. Areas with deeper recesses will appear darker than smooth areas. For the best possible finish match, refer to the 2022 Paris Texas Hardware Finish Chips. These chips have smooth, fluted and carved detailed areas, enabling you to see the beautiful shadings and highlights that make our finishes so special.

Strike-offs: For an additional fee, Paris Texas Hardware can provide a sample of your Portfolio or PTH Perfect Match™ finish on any wood or metal pole as requested. See Retail Price List for upcharge. Customer approval of the strike-off sample is required before production will begin. Touch up paint can be sent to the customer on request, for an additional charge. See Retail Price List for upcharge.

Materials

Some finials, brackets, holdbacks and rings are made of resin composite materials. Resin may be damaged by cutting, drilling or attempting to alter the size or shape of products. Some items are made of cast aluminum or stamped steel. Wood poles and wood rings are made of various hardwoods. Metal poles and metal rings are made of metal or steel.

Poles & Rods

Wood poles may be spliced together using a dowel splicing screw, which is included with each pole. Metal poles may be spliced together using our pole splice, sold separately, or a dowel splicing screw where plastic inserts are included. We recommend a center support bracket for pole lengths in excess of four feet. We cannot guarantee against sagging caused by unsupported spans greater than our recommended four feet.

Finials

All finials are sold as pairs. Most resin finial bases have a 1/8" recess for a clean pole fit. Resin finials are fitted with a dowel screw that may not be removed without damaging the finial. 1 1/8" metal finials are supplied with plastic inserts to attach the finials. 1 3/8" metal finials are fitted with a set screw, which can be tightened using an allen wrench provided.

Brackets

Brackets are sold individually. Depending on the style of the bracket, there are three wall mounting styles; key lock, round mounting plate or front drill. Some heavier treatments may require stronger fasteners (mollies and screws) than those included with the brackets. Brackets should be installed securely into wall studs.

Rings

Rings are sold individually. Eyelets are not detachable from rings. Excessive movement of rings on the top of the pole will naturally abrade the finish. We recommend three to four rings per foot of finished pole length, or six to seven rings per width of fabric.

Production Time

Purchase orders are processed once they are received by Paris Texas Hardware. Incomplete information will delay processing and shipping. Quick Ship collections are in stock and ship within 24 hours. Quick Ship orders received before noon CST ship the same day. Portfolio custom collection is hand finished and ships within 10-15 business days.

Heavy Duty Corded or Baton & Motorized Traverse Systems

Heavy duty traverse systems are available with or without decorative wood fascia, available in 1 3/8" or 2 1/4" smooth, reeded or grooved / fluted profiles with coordinating finials, 1 7/8" slim round smooth profile, 2 1/4" flat smooth profile with flush ends or mitered returns, in Portfolio, PTH Perfect Match™ and Quick Ship Wood & Resin. Production time for traverse system orders is 10-15 business days. Please refer to page 104 for available fascia styles, sizes and finishes.

Metal Baton Draw & Motorized Traverse Systems

Metal traverse systems are available for 1 1/8" and 1 3/8" Portfolio (**except Antique Gold Leaf**), PTH Perfect Match™, Quick Ship Metal and Quick Ship Wood & Resin (**1 3/8" only, requires Transitional Cuff / Finial Adapter sold separately to attach finials**). Production time for traverse system orders is 10-15 business days. Please refer to pages 60 - 67 and 82 - 97 for available metal track sizes and finishes.

Pricing & Terms

Pricing found in the Paris Texas Hardware Price List are our Suggested Retail Prices. Prices are subject to change without notice. Due to the U.S. government's current policy on China tariffs, all products are subject to a tariff surcharge as of September 1, 2019. Prices are quoted exclusive of Freight and Packaging. The Buyer should always inspect the product upon receipt.

IMPORTANT: Please note that your order will be placed with an authorized Paris Texas Hardware Distributor. While most of the following will generally apply, your distributor may have terms and conditions of the sale that will vary from what is stated here.

Returns, Changes & Cancellations

All Portfolio and PTH Perfect Match™ products are custom painted and may not be Returned. Orders may not be changed or canceled once production has begun.

Quick Ship items may be Returned if poles are uncut and all products are received in sellable condition. A restocking fee of 40% will apply and the customer will prepay freight. All Returns must be authorized by the Paris Texas Hardware customer service department, and are authorized at our discretion, given the circumstances and nature of each order. A Return Authorization Number (RA#) must be issued by customer service, and the RA# must be noted on all Return packages. Return Credit is issued on Returned goods that are inspected and deemed undamaged. Customers should exercise care to adequately package Return goods. Return Credit will not be issued for unauthorized Returns or damaged Returns.

Shipping (NET Fees)

All hardware orders are shipped FOB Dallas, Texas. Poles over 96" MUST be shipped by common carrier. Please see the Paris Texas Hardware Retail Price List for applicable Freight and Packaging fees. Expedited shipments are not available in all areas. Any additional charges for expedited shipments will be in addition to the published net fees.

The following orders will be subject to actual freight costs:

- Shipments going to Alaska, Hawaii, Idaho, Montana, Puerto Rico or any international destination.
- Orders with poles or tracks exceeding 96" in length
- Orders that exceed a \$2,500 SRP

Packaging Fees (NET Fees)

A net packaging fee of \$10.00 per order will apply to any order that has a pole. A net packaging fee of \$10.00 will apply to any order with a traverse rod less than 16 feet. The net packaging fee increases to \$25.00 for all orders with rods with returns; motorized traverse track; or poles, rods and corded traversing track 16 feet or longer.

Damaged Goods & Freight Claims

Immediately upon receipt, your order should be inspected to ensure that there is no damage from shipping. To report a claim, contact your Paris Texas Hardware distributor. Damage and freight claims must be made within 15 days of receipt of goods. Claims reported after 15 days will not be accepted. To expedite the claim process, please provide your distributor with the following information: purchase order number, Paris Texas Hardware order number, shipping phone number and address, a complete list of damaged items and a picture of the box/package. Freight companies require all packaging materials and damaged items to be kept for inspection. Merchandise damaged in shipping will be replaced. Our policy is that we replace damaged product per the original order. Please note on the Bill of Lading if there is any possibility of damage. If shipping through a 3rd party, distributor is responsible for claiming damages and the remakes will be at charge.

Installation

We recommend using a professional installer. Installation hardware is included. The fasteners (screws and mollies) may not be appropriate for every installation or wall material. Brackets and holdbacks should be installed securely into wall studs when possible. Paris Texas Hardware will not assume responsibility for damages incurred by improperly mounted or inadequately supported hardware.



For your convenience,

you can unfold this cover to view all of our standard finishes as you browse our product catalog.

PTH Perfect Match™

Looking for that *perfect* hardware finish to match your wall, fabric or furniture?

Allow PTH Perfect Match™ to stir your imagination and inspire you to create your own unique window treatment.



PTH Perfect Match™

Here's How It Works »

Choose any Benjamin Moore® color in either high-gloss or eggshell sheen level.

For a minimal service charge, we will apply your specified color to your Paris Texas Hardware selection and responsibly dispose of any leftover paint.



Make It Your Own »

For a minimal service charge, we will add highlights to your PTH Perfect Match™ hardware selections.

Highlights are only available on PTH Perfect Match™ finishes.

Choose from 4 highlight options »

Silver



Gold



Rose Gold

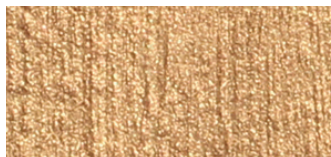

Glitter



Finishes



When you need something in a hurry, our quick ship collections ship within 24 hours!

Quick Ship Metal Finishes

ships within 24 hours



Brushed Nickel
BN

Satin Gold
SG

Rose Gold
RGD

Brushed Bronze
BZ

Charcoal Zinc
CZ

Matte Black
MK

Quick Ship Wood & Resin Finishes

ships within 24 hours



Platinum
PL

Rose Gold
RC

Antique Brass
AB

Walnut
WAL

Oil Rubbed Bronze
ORB

Portfolio Custom Hand Painted Finishes

ships in 10 - 15 business days



Photography may not accurately represent the true color of a finish. A finish may show slight variation when painted on different materials, such as metal, resin or wood. For best possible finish match, please refer to the actual sample chip.



PTH

PARIS TEXAS
HARDWARE™

ParisTexasHardware.com

