

# ORION

ORNAMENTAL IRON, INC.

*Iron Art™* *Wood Art™*  
*by* **ORION** *by* **ORION**

2014 DECORATIVE DRAPERY HARDWARE CATALOG  
*Hand Crafted with Pride Since 1983*



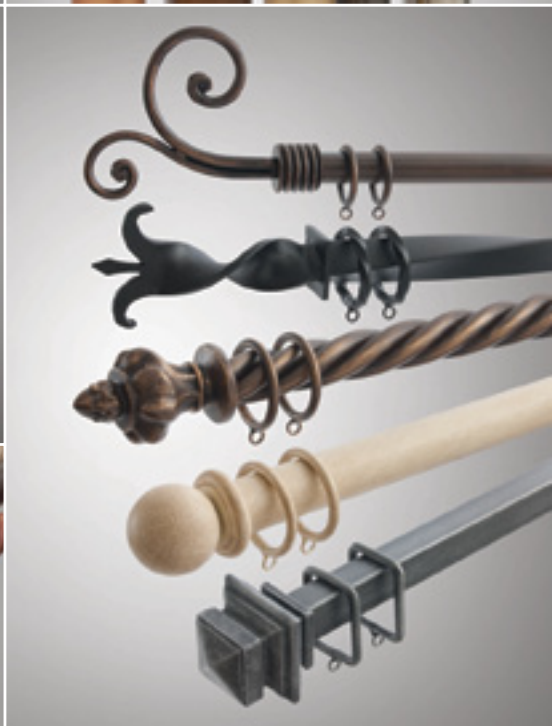
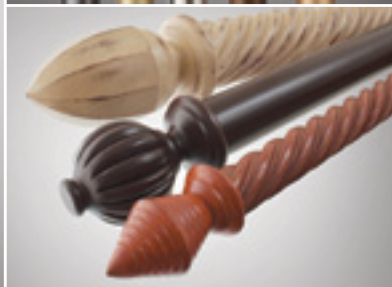

# Contents

## Iron

---

☞ 3D Drapery Hardware (Finials in Front of Rod)	22
☞ Accessories	15
☞ Batons	19
☞ Brackets/Decorative Brackets	16
☞ Burgundy Collection (Hand Crafted Decorative Rods)	28
☞ Fina Collection (Thin Line Drapery Hardware)	21
☞ Finials	6
☞ Iron Art Finishes	72
☞ Italian Collection (Metal Plated Iron Drapery Hardware)	58
☞ Italian Collection Finishes	61
☞ Milano Collection (Roman Shades on Drapery Hardware, Available While Supplies Last)	21
☞ Oasis Collection (Expandable Sets)	20
☞ Rings	17
☞ Rods	15
☞ Swing Arms	17
☞ Tiebacks/Swag Holders	18
☞ Tropical Collection (Faux Bamboo on Iron)	26
☞ Unique Collection (By Pass System with "C" Rings)	20
☞ Vienna Collection (Decorative Scrolls)	30
☞ Village Forge Collection (Hand Crafted Iron Finials)	13
☞ Xpress Yourway (Orion's Quickship Program)	4

## Finials

---

☞ Bohemia Collection (Decorative Hand Crafted Faceted Crystal-Glass Finials)	62
☞ Bohemia Collection on Wood (Decorative Hand Crafted Faceted Crystal-Glass Finials)	64
☞ Eclectic Collection (Glass & Rattan Finials)	14
☞ Finials (Iron)	6
☞ Italian Collection (Metal Plated Iron Drapery Hardware)	58
☞ Provence Collection (Decorative Hand Blown Art Glass Finials, Available While Supplies Last)	14
☞ Village Forge Collection (Hand Crafted Iron Finials)	13
☞ New York Wood Collection (Exclusive Hand-Painted Wood Finials)	70
☞ Rosina Collection (Decorative Resin Finials)	68
☞ Wood Craft Collection (Hand Carved Finials, Swag Holders, Brackets and Batons, Available While Supplies Last)	66

## Cornices, Crowns, Decorative Scroll Work and Valances

---

☞ Clip-A-Crown (Lightweight Decorative Metal Valance Over Blinds)	36
☞ Mediterranean Collection (Lightweight Decorative Crowns)	30
☞ Renaissance Collection (Lightweight Decorative Cornices)	31
☞ Tuscany Collection (Decorative Metal Cornices)	32
☞ Vienna Collection (Decorative Scrolls)	30

## Manual and Motorized Traversing

---

☞ Deco Lite Traversing (Lightweight Embossed Metal Panels)	50
☞ Designers' Choice Traversing Rods (Iron & Wood Traversing Rods with Heavy Duty Hardware)	42
☞ Manual Traversing Accessories	49
☞ Motorized Traversing Accessories	56
☞ Traversing with Somfy Motorization	52
☞ Tuscany Traversing Collection (Lightweight Embossed Metal Rods and Heavy Duty Hardware)	46

## Wood and Resin

---

☞ New York Wood Collection (Exclusive Hand-Painted Wood Finials)	70
☞ Rosina Collection (Decorative Resin Finials)	68
☞ Wood Art Finishes	74
☞ Wood Craft Collection (Hand Carved Finials, Swag Holders, Brackets and Batons, Available While Supplies Last)	66
☞ Wood Poles & Accessories	67
☞ Measurement Guidelines	75
☞ Promotional Items/Designer Product Case	71
☞ Xpress Yourway (Orion's Quickship Program)	4

# XPRESS YOURWAY

Quality and Elegance Shipped Faster

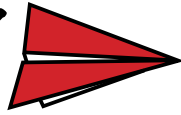

Our most popular Iron Art™, Bohemia, and Italian finials with expedited shipping.

Two finish collections determine the shipping speed. Express It! finishes are shipped the next business day while Quicken It! finishes are shipped within 3 business days. Choose from eight finials in either our Iron Art or Italian Collections. Complete your set with mounting hardware, rings and accessories!

**Iron Art Line** - 1" and 1½" rod sizes, eight finials, and six finishes. Coordinate with accessories, brackets and rings.

## Express It! Finishes Next Day Shipping

## Quicken It! Finishes 3 Day Shipping



Black



Brown



Antique Bronze



Antique Gold



Soft Pewter



Pure White



**513**  
(1" x 2¼")



**420**  
(1¾" x 2")



**946**  
(2" x 2")



**505**  
(2¼" x 1½")



**947L**  
(2½" x 2½")



**906S**  
(3¼" x 3")



**966**  
(3½" x 2¼")



**950**  
(5¼" x 2½")

### End Caps, Sockets & Rings

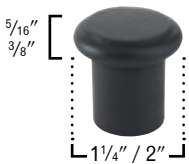

**321 Decorative Cap**  
(For 1" & 1½" Rods)



**Socket**  
306-100 (1" Rod)  
306-112 (1½" Rod)



**350 Round Ring**  
(For 1" & 1½" Rods)

**1016 Baton with Clip**  
Length: 48"  
Diameter: ½"

### Mounting Brackets

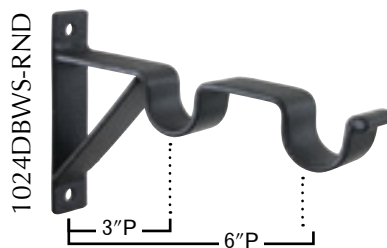

### Expandable Post Projection Tiebacks (3" to 4½" projection)



**1059 Rosette**  
(3" Diameter)



**1073**  
(3½" Diameter)



**1078**  
(3¾" x 3¾")



**Italian Line** - 1" round rod, eight finials, and two finishes. Coordinate with accessories, brackets and rings.

**Express It! Finishes**  
Next Day Shipping

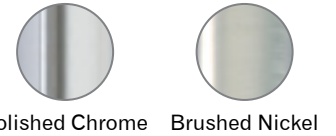

<b>778</b> (1 1/4" x 2 3/8")	<b>774</b> (2" x 2 3/4")	<b>775</b> (2 3/4" x 2 1/2")	<b>788</b> (3 1/2" x 2")	<b>787</b> (3 1/2" x 2")	<b>7003</b> (2" x 2")	<b>7005</b> (2" x 1 1/8")	<b>7006</b> (2" x 1")
---------------------------------	-----------------------------	---------------------------------	-----------------------------	-----------------------------	--------------------------	------------------------------	--------------------------

**End Caps & Rings**

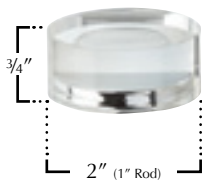

**790**  
Crystal End Cap



**7016**  
Metal End Cap



**7013**  
Ring with Eyelet  
(1/4" thick)

**Mounting Brackets**



**7014 3"P**

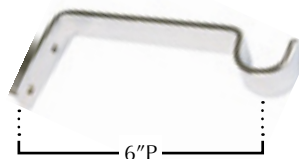

**7015 6"P**

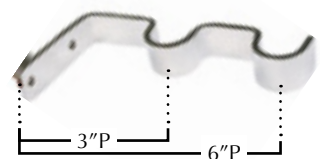

**7040**



**1014 Baton with Clip**  
Length: 48" : Diameter: 1/2"

**Ordering Information:**

1. All orders received by 12:00 noon Pacific time will be considered same day orders. Shipping times are in business days.
2. Finials are interior fit only.
3. Modifications from specifications offered will not qualify for the Xpress Yourway program.
4. Cancellation of orders will result in a 35% restocking fee.
5. Please utilize the Xpress Yourway order form or mark orders as Xpress Yourway.  
Orders without an Xpress Yourway indication will be processed with standard shipping times.
6. Xpress Yourway Wall Display is available. Please see item #8002 on page 71.

# *New Finial Designs*

## *15 New Styles*



**Finial 550**  
6<sup>3</sup>/<sub>8</sub>" Long x 4" High x <sup>3</sup>/<sub>4</sub>" Deep  
Shown in Rich Gold (07) on a 1" round rod.



**Finial 551**  
3<sup>7</sup>/<sub>8</sub>" Long x 3<sup>7</sup>/<sub>8</sub>" High x <sup>5</sup>/<sub>8</sub>" Deep  
Shown in Burnt Gold (25) on a 1" round rod.



**Finial 552**  
4<sup>1</sup>/<sub>4</sub>" Long x 4<sup>1</sup>/<sub>4</sub>" High x 1" Deep  
Shown in Soft Pewter (13) on a 1<sup>1</sup>/<sub>4</sub>" fluted rod.



**Finial 553**  
4" Long x 4" High x 3<sup>1</sup>/<sub>4</sub>" Deep  
Shown in Antique Bronze (02) on a 1<sup>1</sup>/<sub>4</sub>" twist rod.



**Finial 554**  
3<sup>5</sup>/<sub>8</sub>" Long x 3<sup>5</sup>/<sub>8</sub>" High x 3<sup>5</sup>/<sub>8</sub>" Deep  
Shown in Soft Pewter (13) on a 1<sup>1</sup>/<sub>4</sub>" fluted rod.



# *New Finial Designs*

## *15 New Styles*



**Finial 555**  
 6<sup>7</sup>/<sub>8</sub>" Long x 6<sup>3</sup>/<sub>8</sub>" High x 1" Deep - 1<sup>1</sup>/<sub>2</sub>" at base  
 Shown in *Black (14)* on a 1<sup>1</sup>/<sub>2</sub>" square rod.



**Finial 9704**  
 2" Long x 1<sup>1</sup>/<sub>2</sub>" High x 1<sup>1</sup>/<sub>2</sub>" Deep  
 Shown in *Brown (19)* on a 3/4" square rod.



**Finial 556**  
 6<sup>3</sup>/<sub>8</sub>" Long x 2<sup>1</sup>/<sub>8</sub>" High x 1<sup>1</sup>/<sub>2</sub>" Deep - 1<sup>3</sup>/<sub>8</sub>" at base  
 Shown in *Naturelle (03)* on a 3/4" rope rod.



**Finial 9705**  
 2" Long x 1<sup>1</sup>/<sub>8</sub>" High x 1<sup>1</sup>/<sub>8</sub>" Deep  
 Shown in *Light Brown (09)* on a 3/4" round rod.



**Finial 557**  
 6" Long x 1<sup>5</sup>/<sub>8</sub>" High x 1<sup>1</sup>/<sub>4</sub>" Deep - 1<sup>1</sup>/<sub>4</sub>" at base  
 Shown in *Naturelle (03)* on a 3/4" rope rod.



**Finial 9705L**  
 3" Long x 1<sup>3</sup>/<sub>4</sub>" High x 1<sup>3</sup>/<sub>4</sub>" Deep  
 Shown in *Antique Gold (06)* on a 1<sup>1</sup>/<sub>4</sub>" round rod.



**Finial 558**  
 2" Long x 2<sup>5</sup>/<sub>8</sub>" High x 2<sup>5</sup>/<sub>8</sub>" Deep - 1<sup>3</sup>/<sub>4</sub>" at base  
 Shown in *New Nickel (12)* on a 1" square rod.



**Finial 9706**  
 2" Long x 1" High x 1" Deep  
 Shown in *Black (14)* on a 3/4" square rod.



**Finial 559**  
 1<sup>1</sup>/<sub>8</sub>" Long x 2<sup>1</sup>/<sub>4</sub>" High x 2<sup>1</sup>/<sub>4</sub>" Deep  
 Shown in *Bronze Vecchio (15)*  
 on a 1" hammered twist rod.



**Finial 9706L**  
 3" Long x 1<sup>3</sup>/<sub>4</sub>" High x 1<sup>3</sup>/<sub>4</sub>" Deep  
 Shown in *Antique Copper (10)*  
 on a 1<sup>1</sup>/<sub>2</sub>" square rod.

# Finials

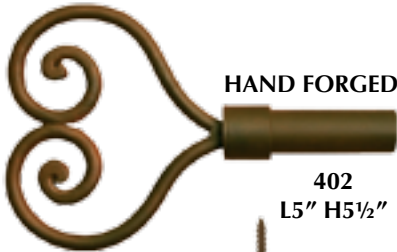
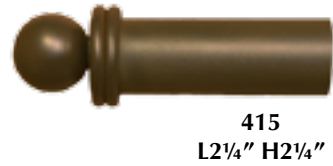

403  
L8" H6½"  
HAND FORGED  
Shown as  
Ceiling Mount.  
Also available  
as Finial.

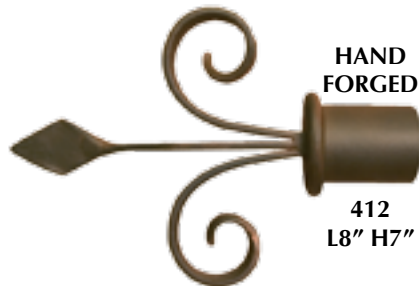
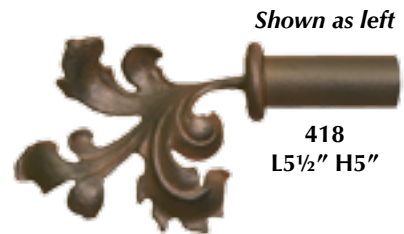
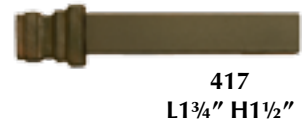
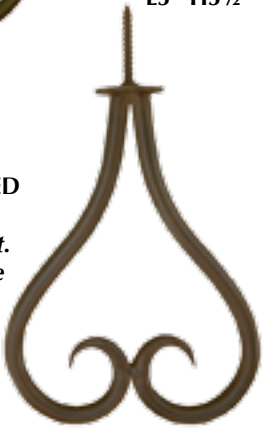



# Finials



421  
L6½" H3¼"



Only available as shown.  
422  
L3½" H5¾"



501  
L6" H6"



502  
L4" H4"



503  
L8" H4"



505  
L2¾" H1½"

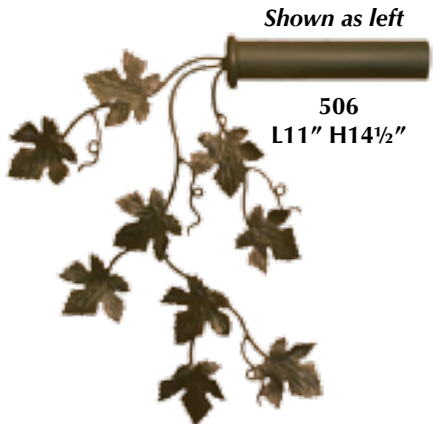

Shown as left  
506  
L11" H14½"



Shown as left  
507  
L9¼" H8¼"



508  
L6¾" H8"



509  
L9½" H8"

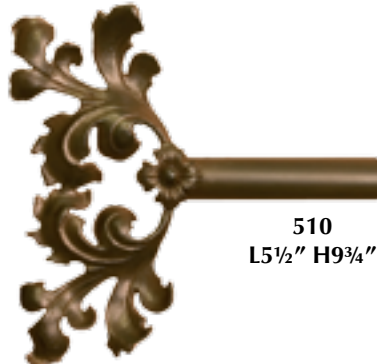

510  
L5½" H9¾"



511  
L1" H2"



512  
L1¼" H2¼"



513  
L1" H2¼"



HAND FORGED  
Shown as left  
707  
L6½" H5¾"

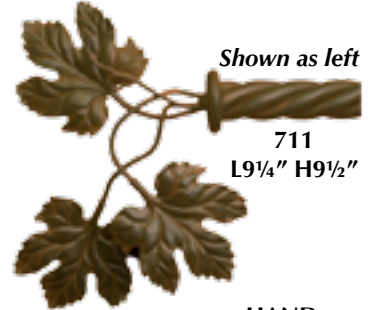

Shown as left  
711  
L9¼" H9½"

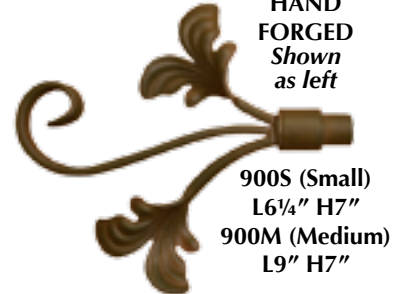

HAND FORGED  
Shown as left  
900S (Small)  
L6¼" H7"  
900M (Medium)  
L9" H7"



901  
L7½" H3¾"



902  
L7¾" H4¼"



903  
L5½" H4"



904S (Small)  
L6" H2¾"



904L (Large)  
L9" H4¼"

...to enhance your home!

# Finials

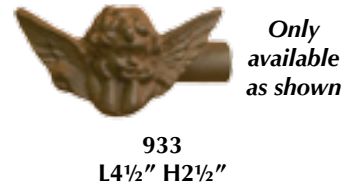
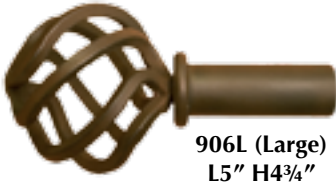

HAND FORGED



HAND FORGED



909  
L8" H2½"



HAND FORGED

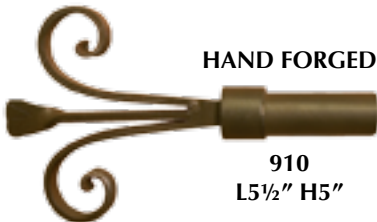

911  
L5½" H2¾"



# Finials

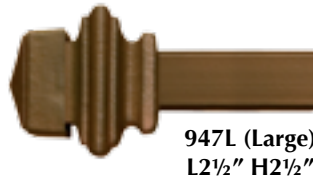
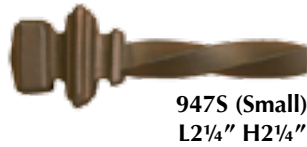
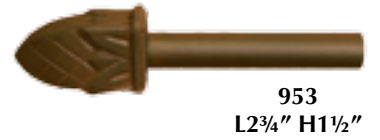
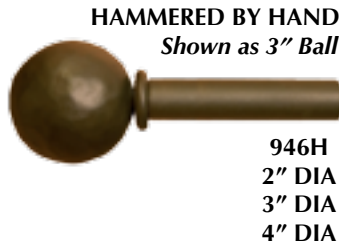
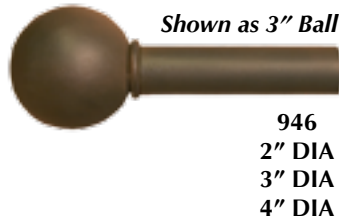

*..just let your imagination take over!*

# Finials

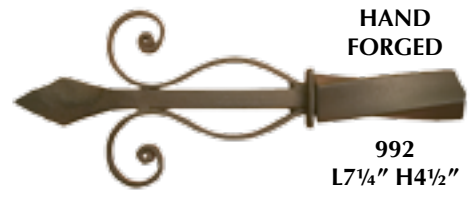
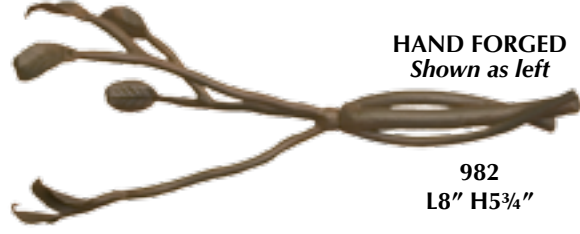
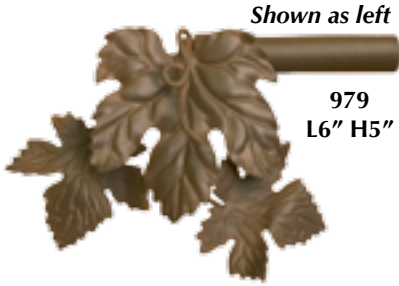

# Village Forge Collection

## Hand Crafted Iron Finials

All finials shown as left.



Finial: 600  
Finish: Autumn  
L7½" H9"



Finial: 604  
Finish: Burnt Silver  
L7½" H2¾"



Finial: 601  
Finish: Rich Gold  
L8½" H6"



Finial: 605  
Finish: Antique White  
L6½" H6"

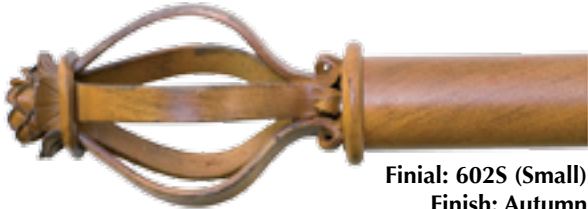

Finial: 602S (Small)  
Finish: Autumn  
L5¾" H3⅛"



Finial: 606  
Finish: Bronze Vecchio  
L8¼" H7¼"



Finial: 602L (Large)  
Finish: Burnt Silver  
L7" H4¼"



Finial: 607  
Finish: Cherry Gold  
L9" H4¾"



Finial: 603  
Finish: Antique Copper  
L8½" H8"



Finial: 608  
Finish: Cherry Gold  
L6" H6"

*Journey into Wrought Iron Craftsmanship.*

# Provence Collection

## Decorative Hand Blown Art Glass Finials

All finials: Exterior fit only. Available to fit 3/4" and 1" diameter, Straight Round Hollow Rods. Not available as Tiebacks.  
Available While Supplies Last.



Finial: 830  
L4 1/2" H3"  
Rod Finish:  
Brushed Nickel



Finial: 833  
L4 1/2" H3"  
Rod Finish:  
Antique Gold



Finial: 836  
L3 1/4" H3 1/4"  
Rod Finish:  
Antique Copper



Finial: 831  
L4 1/2" H3"  
Rod Finish:  
Rich Gold



Finial: 834  
L4 1/2" H3"  
Rod Finish:  
Brushed Nickel



Finial: 837  
L3 1/4" H3 1/4"  
Rod Finish:  
Antique Bronze



Finial: 832  
L4 1/2" H3"  
Rod Finish:  
Antique Copper



Finial: 835  
L3 1/4" H3 1/4"  
Rod Finish:  
Black

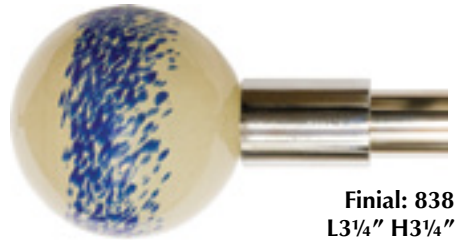

Finial: 838  
L3 1/4" H3 1/4"  
Rod Finish:  
Polished Chrome

# Eclectic Collection

All finials: Exterior fit only. Available to fit 3/4" & 1" rods only. Not available as Tiebacks.  
All rattan and glass finials are available with connectors in black or Italian finishes. Available While Supplies Last.



801  
L4 1/2" H2 3/4"



802  
L5 1/2" H3 1/2"



803  
L4 1/2" H3"

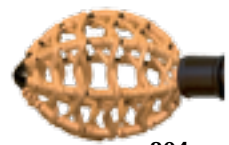

804  
L4 1/2" H3"



805  
2 3/4" DIA



806  
L3" H2 1/2"



807  
L4 3/4" H2 3/8"



808  
L4 3/4" H2 3/8"



Available  
in Italian  
Connectors  
only

809  
L6 1/4" H3 1/4"



Available  
in finish as  
shown only

810  
L5 1/4" H5 1/4"



Available  
in finish as  
shown only

811  
L5 1/4" H5 1/4"

# Iron Art Accessories

**214 HOOK**  
L3" H1 1/4" P1 1/2"  
Available in specified size only

**300 CONNECTOR**

**301 CAP**  
Interior Fitting

**SOCKETS**

**302**

**303**

**304 PEG 1**  
2 3/4" DIA

**Side View**

**305 PEG 2**  
2" DIA

**307 MITER PER CUT**  
Must order interior Elbow (#109) to fit inside Mitered Corner

**308 DECORATIVE SOCKET**  
L5" H2"

**309 ELBOW**  
Shown as 90° Exterior  
Also available as 45°  
Available as Interior Fitting.

**310 HOOK PEG**  
L2 3/4" H3 1/2"

**311 HOOK BRACKET**  
P3"

**312 CORNER BRACKET**  
3" to 4 1/2" P, shown as 45°  
Also available as 90°

**313 KNOB**  
H1"  
1/4" Thick

**314 HOOK**  
P1 1/2"

**315 MOVABLE ELBOW**  
Interior Fitting

**RING BRACKETS**

**316S (Small)**  
3" to 5" ID  
1/8" thickness

**316L (Large)**  
6" to 12" ID  
1/2" thickness

**320 MOVABLE CORNER BRACKET**  
3" to 4 1/2" P  
Interior Fitting

**321 DECORATIVE END CAP**  
Interior Fitting

## Rods

*Rings are not included. Please order separately. Additional charges for threading the rods apply.*

ROUND HOLLOW ROD



ROUND HOLLOW HAMMERED ROD



SOLID ROUND ROD



SOLID ROUND HAMMERED ROD



TWIST HOLLOW ROD



TWIST HOLLOW HAMMERED ROD



SQUARE HOLLOW ROD



SQUARE HAMMERED HOLLOW ROD



ROPE ROD



WOOD GRAIN SOLID ROD



FLUTED ROD Only available as 1 1/4" OD



WIRE ROPE ROD (Rings are welded. Please specify spacing.)



*...always a first at Orion!*

# Brackets

We recommend brackets at a distance of every 48" for normal use.  
Please see the Bracket Guide on page 16 of the Price List for sizes.

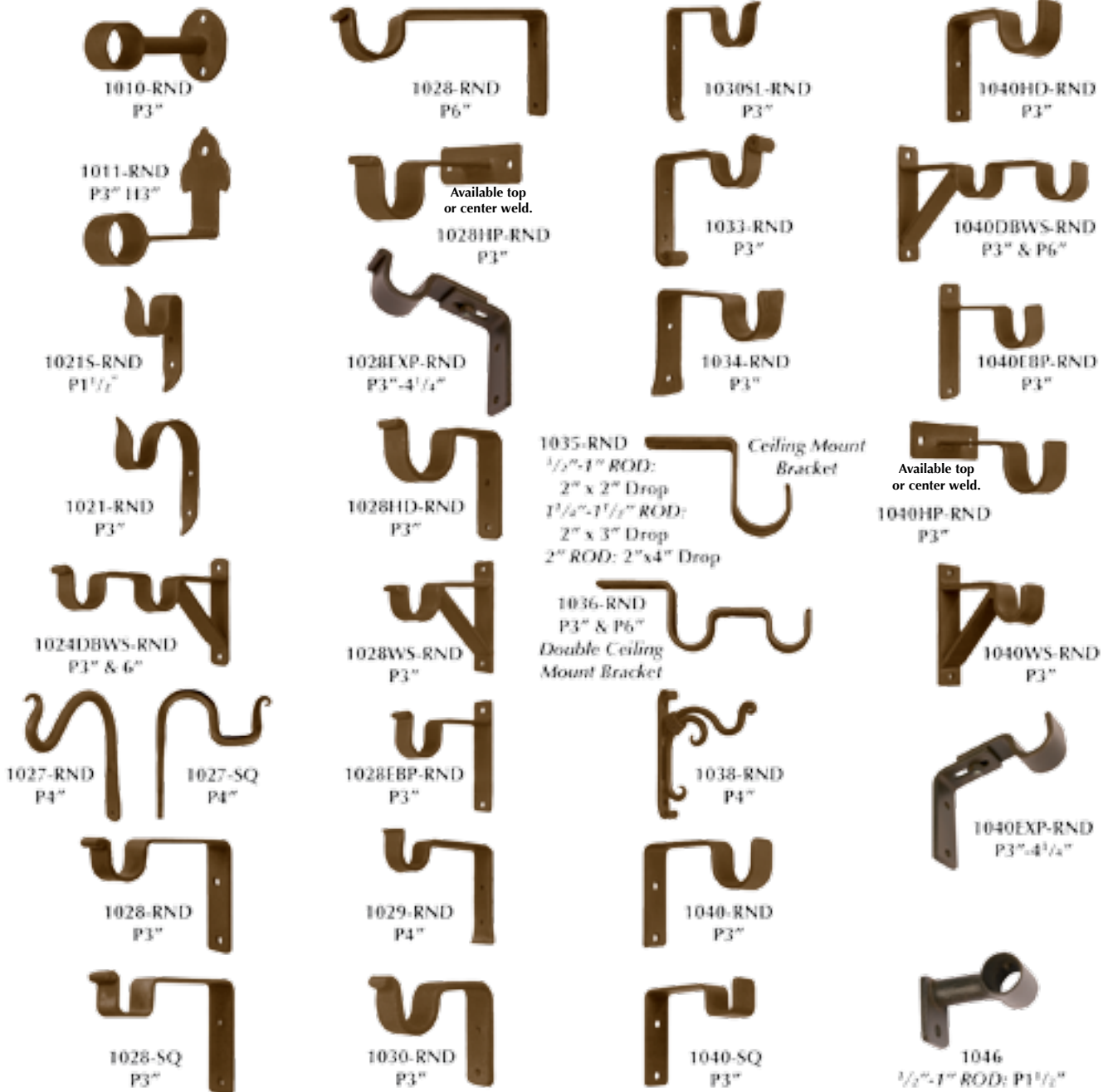

# Decorative Brackets

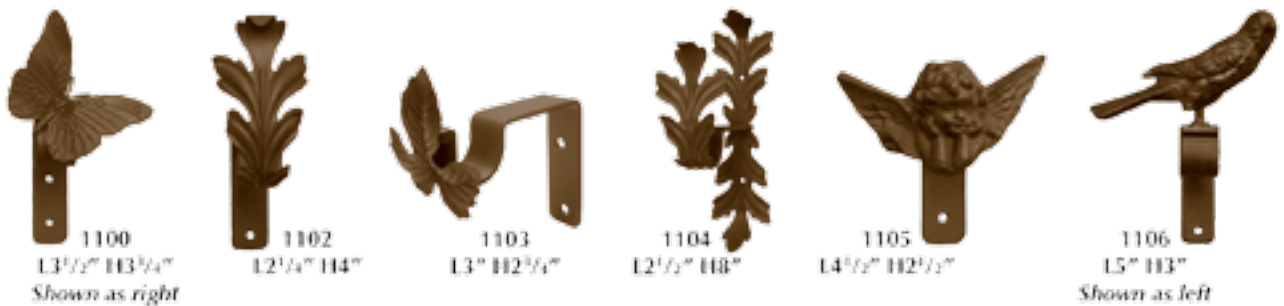



# Rings



We recommend ring size to be 1/2" LARGER than rod diameter.

Eyelets can be modified as per drawing, additional charges apply. Please see the Ring Guide on page 18 of the Price List for sizes.

# Swing Arms

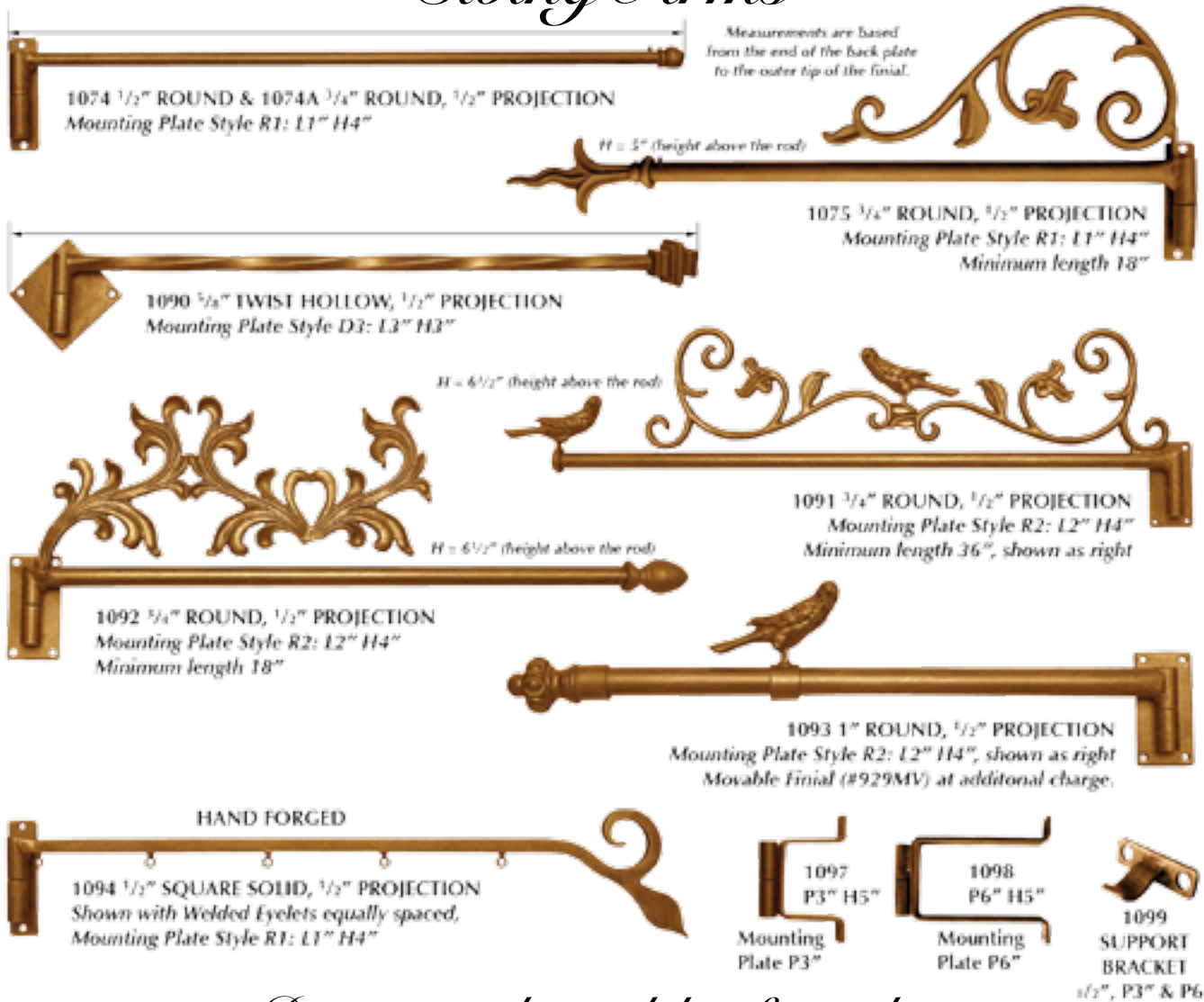

*Distinctive styling, solid craftsmanship!*

# Tiebacks/Swag Holders

Tiebacks/Swag Holders are available as 3" to 4½" Expandable Post Projection or "U" Shape Bend.  
Additional charges will apply for any modification. When ordering, please specify Post Projection or "U" Shape.  
If not specified, style shown in the catalog will be sent.

"U" Shape Bend  
shown as right



715  
L8½" H4"



1005  
2¾" DIA



1032  
L4½" H6¼"



1060  
ROSETTE  
3¾" DIA

"U" Shape Bend  
shown as right

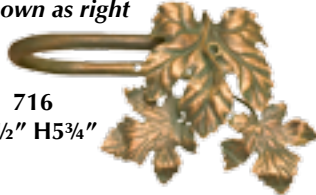

716  
L8½" H5¾"



1006  
L9" H4¼"

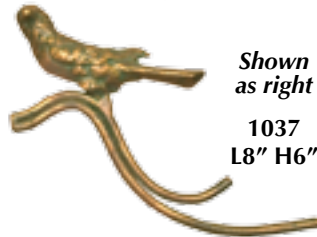

Shown  
as right

1037  
L8" H6"



1061  
ROSETTE  
4½" DIA



Post Tieback  
shown as left

929TB  
L5" H3"



1007  
L12½" H4¾"

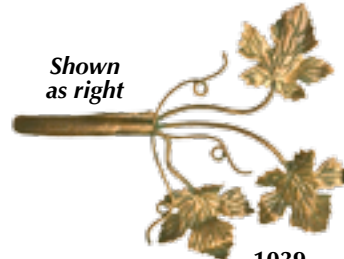

Shown  
as right

1039  
L9¾" H8"



1063  
POPPY  
2¾" DIA



Only  
available  
as shown

933TB  
L4½" H2½"



1008  
L13¼" H5¼"



1064  
FLEUR DE LIS  
L4¾" H5¾"



977  
HORSESHOE  
L4¾" H5¼"

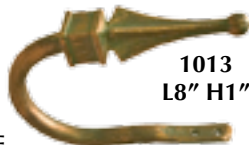

1013  
L8" H1"



1057  
L10" H7¾"



1065  
MOON  
L4" H4½"  
Only  
available  
as shown



1003  
L4¾" H4¾"



1026  
L3" H6"



1058\*  
ROSETTE  
3" DIA



1066  
STAR  
L5¼" H5¼"



1004  
L4¾" H5"



1031\*  
3½" DIA



1059\*  
ROSETTE  
3" DIA



1067  
LION  
L4½" H5½"

# Tiebacks/Swag Holders

Tiebacks/Swag Holders are available as 3" to 4½" Expandable Post Projection or "U" Shape Bend.  
Additional charges will apply for any modification. When ordering, please specify Post Projection or "U" Shape.  
If not specified, style shown in the catalog will be sent.



1068  
OAK  
L7½" H3¾"  
Post Tieback  
shown as left



1073  
3½" DIA



1080  
4¼" DIA



1085  
L3" H6¼"



1069  
ROMAN  
L12" H6½"  
Post Tieback shown as left



1076  
L3" H4¾"



1081  
L7" H6½"  
Only available as shown

Flush Mount Swag

1086  
3" DIA  
Flush Mount Swag



1070  
ROSE  
L8" H4¼"  
Post Tieback shown as left



1077  
L3" H6¼"



1082  
L2½" H6¾"



Front View

Side View



1071  
SWIVEL TIEBACK  
L6¾" H11"  
HAND FORGED



1078  
3¾" DIA



1083  
L4" H4¼"

1088  
POST PROJECTION  
BACK PLATE  
Expandable from  
3" to 4½"  
Mounting Plate is 2"



1087  
"U" SHAPE BEND  
Projection 3½"

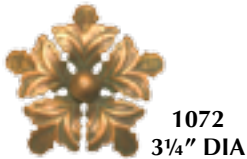

1072  
3¼" DIA



1079  
6¼" DIA



1084  
L3½" H9"

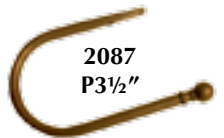

2087  
P3½"

## Batons

Specify Ring or Clip

Available with or  
without eyelet.

Available with or  
without eyelet.



1015

1016

1017

1018

1019

1020

- 1015: IRON ROUND ROD ½" DIA
- 1016: IRON ROUND ROD ½" DIA
- 1017: IRON TWIST ROD ¼" DIA
- 1018: IRON ROUND ROD ½" DIA
- 1019: IRON SQUARE ROD ½" DIA
- 1020: IRON ROUND ROD ½" DIA  
W/ WOODEN HANDLE

...for a complete, coordinated look!

# Unique Collection

## By Pass System with "C" Rings

Available in 3/4" diameter and above. Straight Round Hollow Rods only.  
Available in all Iron Art™ and Italian Collection finishes. Shown in Soft Pewter.



### RINGS



330C  
"C" RING

Single Rod System

Double Rod System



Side View

1045

Top View

### BRACKETS



1028SE  
3"P SINGLE  
END BRACKET



1028SE  
6"P SINGLE  
END BRACKET



1024DE  
3" & 6"P  
DOUBLE END  
BRACKET



318SC  
3"P SINGLE  
SUPPORT  
BRACKET



318SC  
6"P SINGLE  
SUPPORT  
BRACKET



319DC  
3" & 6"P  
DOUBLE  
SUPPORT  
BRACKET

# Oasis Collection

## Expandable Sets

Rod diameter is a combination of 1" & 7/8"



913 ES  
L3 3/4" H3"



946 ES  
2" DIA



916 ES  
L2" H1 1/2"



956 ES  
L6 1/4" H4 1/4"

Sets are available as:		
Small	27"-48"	2 Brackets
Medium	45"-82"	3 Brackets
Large	81"-118"	3 Brackets
Extra Large	117"-154"	4 Brackets
All sets include Rods, Finials and Brackets.		

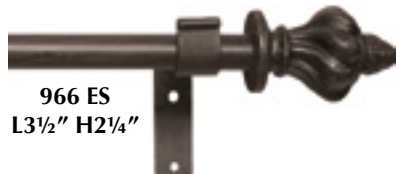

966 ES  
L3 1/2" H2 1/4"

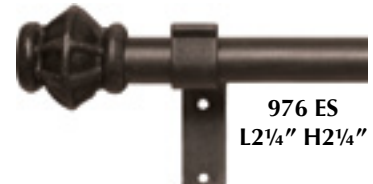

976 ES  
L2 1/4" H2 1/4"

# Milano Collection

## Roman Shades on Drapery Hardware

Shown as assembled set. Available as round 5/8" diameter rod only. Available While Supplies Last.

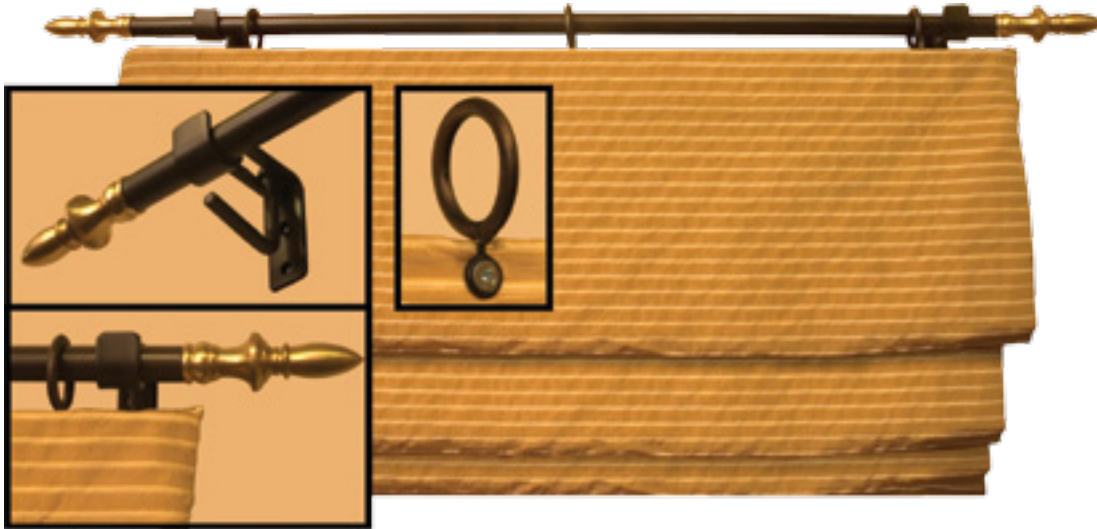

2080  
P2"

2081  
P3"

2082  
P2"

2083  
P3"

2084  
P3" & P6"



Variations in glass colors may occur.

2094: L4" H3"    2095: L2" H2 1/4"  
Exterior fit only.



2088  
EXTENDED EYELET



2070  
L1 1/4" H3/4"



2071  
L1 1/4" H1"



2072  
L1/2" H1"



2073  
L1 1/2" H1/2"



2074  
L3" H1"



2075  
L2 1/2" H1 1/4"

Interior fit only. These finials are also available in a brass finish. Variations in tones may occur.

## Fina Collection Thin Line Drapery Hardware

Available for 1/2" rod diameter only. Finials as exterior fit only. Rod and rings not included.



2060  
L3 1/2" H1 3/4"



2010  
L1 1/4" H1 1/2"



2020  
L4" H2 1/2"



2030  
L4 1/2" H3"



2050  
L4 1/8" H1 3/4"



2040  
L4 1/4" H1"



2025  
L5 1/4" H2 3/4"



2015  
3/4" DIA

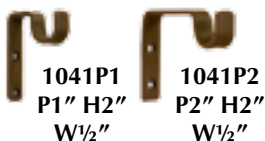

1041P1  
P1" H2"  
W1/2"

1041P2  
P2" H2"  
W1/2"



2087  
P3 1/2"

# 3D Drapery Hardware

## Finials in Front of Rod



Explore new window designs with the ability to have the finial in front of the rod. Finials can also be manually adjusted to be above or below the rod simply by changing their position to enhance the window covering presentation.

Combined with our master carriers, which help reduce light gaps, this system is also great for tight areas where you may not be able to fit the finial you would like to use when using conventional drapery hardware.

Nearly all our finials are available for use with the 3D system (some exceptions are listed on page 23). Rods are 1" diameter in either round hollow smooth (Iron and Italian) or hammered styles (Iron only). Choose from 35 Iron Art™ finishes, 5 Italian finishes, or your own custom finish.

# 3D Drapery Hardware

## Finials in Front of Rod

3D Drapery Hardware can be used with single or double rod systems. Back rods in the double rod system are the same length as the front rod, including their end caps. Straight master carriers allow the drapery to pass the end brackets, giving you maximum window coverage. Begin your order by selecting your 3D Drapery Hardware Kit from the selections below.

### 3D Drapery Hardware Kits:

#### 3D Single Kit:

- Two 180° U-Bends for one iron rod.
- Two straight master carriers for rings.
- Four rings (two for each straight carrier).

#### 3D Double Kit:

- Two 180° U-Bends for one iron rod.
- Four straight master carriers for rings.
- Eight rings (two for each straight carrier).
- Two end caps for one back rod.

Description	Item #
3D Single Kit for Iron Art Finishes	3D-SIA
3D Single Kit for Italian Finishes	3D-SIT

Description	Item #
3D Double Kit for Iron Art Finishes	3D-DIA
3D Double Kit for Italian Finishes	3D-DIT

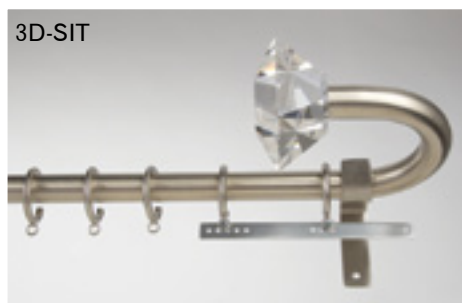

Kit images shown with additional rings.

### Drapery Hardware:

#### 1" Round Hollow Rods

- Available in 35 Iron Art finishes, 5 Italian finishes, or your own custom finish.
- May be used with By Pass Rings.

#### 1" Round Hollow Hammered Rods

- Available in 35 Iron Art finishes, or your own custom finish.
- **Not for use with By Pass Rings.**

#### Finials

- Choose from almost any Iron Art finial, all Italian finials, and all Bohemia Crystal finials. (See exceptions listed under Finials.)

#### Brackets

- Brackets ordered for use with the 3D system include lids and set screws to keep rods secure.

#### Rings

- Choose from any style of ring.

#### Overlap Master Carrier Set (optional):

- Works with center open draperies and rings for complete drapery closure in the front.

### Finishes:

Iron Art drapery hardware is available in 35 Iron Art finishes, or your own custom finish. Italian drapery hardware is available in five Italian finishes: Brushed Nickel, Black Nickel, Oiled Bronze, Satin Copper and Satin Gold. *Polished Chrome is not available for 3D Drapery Hardware.*

### Rods:

Choose from 1" diameter round hollow rods in smooth or hammered styles. Order by your rod length tip to tip. (See measurement guidelines on page 25.)

Iron Art Rods	Italian Rods
Description	Description
1" Diameter Round Hollow Rod	1" Diameter Round Hollow Rod
1" Diameter Round Hollow Hammered Rod	

### Finials:

**Because of their size and branch shape, we don't recommend the 3D system for use with Iron Art finials 410, 416, 506, 711, 939, 954, 979 and 982, and Village Forge finials 600, 601, 603 and 606. All other Iron Art finials, Italian finials and Bohemia Crystal finials may be utilized.**

# 3D Drapery Hardware

Position the U-Bends from horizontal to vertical, and anything in between, with the use of our brackets with lids and set screws.



## Brackets:

Choose from any of our Iron Art brackets. We will add lids and set screws to keep your rods secure, allowing you to position the 3D rod at various angles.

## Rings:

Choose from any of our Iron Art rings. 3D Kits and Overlap Master Carrier Sets will come with two matching rings for each carrier.

## By Pass System:

3D Drapery Hardware using smooth rods can be utilized with our Unique Collection support brackets and "C"-rings for one way draw.



Single Support Bracket

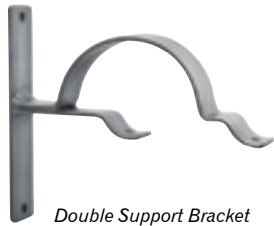

Double Support Bracket



Round Iron "C"-Ring

Unique Collection support brackets and "C"-Rings. (For smooth rods only. Not available for hammered rods.)



Single rod system shown with one way draw in Italian finish Brushed Nickel.



Double rod system shown with one way draw in Iron Art finish Soft Pewter.



# 3D Drapery Hardware

## Finials in Front of Rod

### Overlap Master Carrier Set (optional):

This set works with center open draperies and rings for complete drapery closure.

Description	Item #
Overlap Master Carrier Set in Iron Art Finishes	MCS-IA
Overlap Master Carrier Set in Italian Finishes	MCS-IT

### What's Included:

- One straight master carrier for rings.
- One overlap master carrier for rings.
- Four rings (two for each carrier).



Overlap Master Carrier Set with Rings.



Overlap Top View.



Single hammered rod system shown as center open in Iron Art finish black.

### Measurement Guidelines:

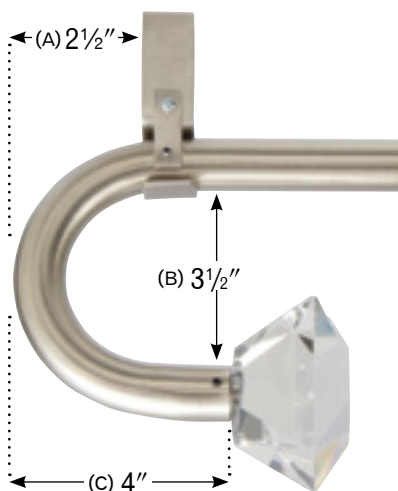

- A) The distance from the end of the straight rod to the edge of the curve is  $2\frac{1}{2}$ ".
- B) The U-Bend projection is  $3\frac{1}{2}$ ".
- C) The front face of the U-Bend is 4" long, not including the finial.
- D) **Order your rod length tip to tip.**
- E) Available in 1" diameter round hollow smooth or hammered styles, single or double rod systems. Back rods in the double rod system are the same length as the front rod, including their end caps.

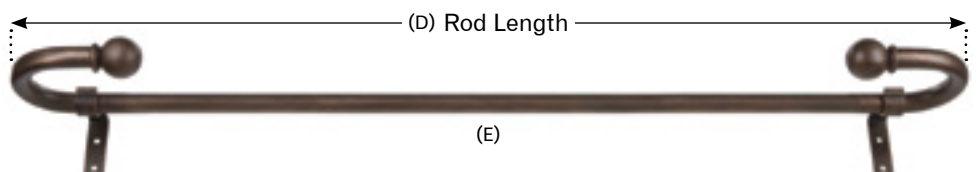

# Tropical Collection

## Faux Bamboo on Iron

### Finials



Side View

9000  
PALM LEAF  
L5 1/4" H9"

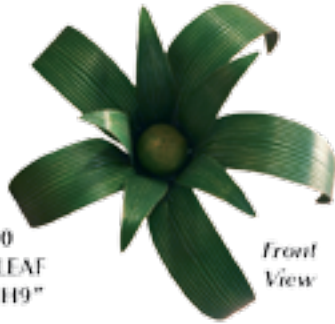

Front View



Side View

9003  
SHELL  
L5 3/4" H4"



Top View



Side View

9001  
BAMBOO LEAVES  
L6 1/2" H7"



Front View



Side View

9004  
BAMBOO CAP  
L 1/8" H2"



Front View



Side View

9002  
COCONUT  
L7 1/4" H5"

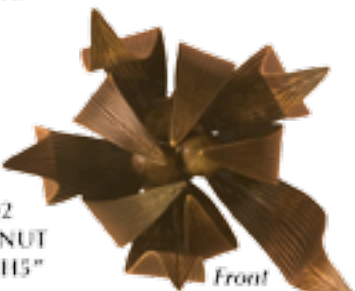

Front View



Left

9005  
TROPICAL ACCENT  
L5 3/8" H6"

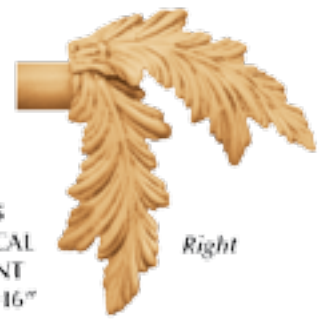

Right

### Decorative Cornices

Optional Wood Duster available. Refer to Product #8046 and #8047 (Tuscany Collection) in Price List

Front View



Detail View



9040  
(Shown as H3 1/2")  
Also available as 9040D (H15 1/2")

MOTORIZATION &  
CORD DRAWN Tracks  
Available!  
Call for Quote!

# Tropical Collection

## Faux Bamboo on Iron

### Rods



9020 3/4", 1", 1 1/4", 1 1/2" and 2" DIA STRAIGHT RODS



9020BT 3/4", 1", 1 1/4", 1 1/2" and 2" DIA BENT RODS



9022 3/4", 1", 1 1/4", 1 1/2" and 2" DIA DECORATIVE RODS

### Swing Arms

Measurements are based from the end of the back plate to the outer tip of the finial.



9046 1" Round Rod, 1/2" Projection, Mounting Plate 12" H4"

### Tiebacks



9060 P3 1/2"

### Baton

Specify Ring or Clip



9050 Rod 5/8" DIA Available in 18" long only

### Brackets



9010 3"P



9011 6"P



9012 DOUBLE 3" & 6"P



1263 3"P Single Traverse/Rod Combination

Also available in 6"P Single and 3" & 6" Double Traverse Bracket

### Rings



9025 ROUND Thickness 3/4"



9029 FLAT Width 3/4"



8006 TROPICAL FINISH SELECTOR SET

### Finishes

Also available in High Gloss Finish. Please add 20% charge.



TC201 YELLOW TIGER



TC202 BLACK TIMOR



TC203 NATURAL BROWN



TC204 RED BAMBUSA



TC205 GREEN CANE



TC206 RUSTIC BAMBOO

...in your home!

# Burgundy Collection

## Hand Crafted Decorative Rods



251 VINEYARD H3<sup>1</sup>/<sub>2</sub>"



251B (BENT)  
VINEYARD H3<sup>1</sup>/<sub>2</sub>"  
Curve as per template.



252 SOLID BRANCH, approx. H3"



253 SOLID SNAKE, <sup>5</sup>/<sub>8</sub>" Diameter, approx. H2"



254 ROUND WRAPPED  
WITH GRAPEVINE LEAVES,  
<sup>3</sup>/<sub>4</sub>" shown, approx. H10"



254B ROUND WRAPPED WITH GRAPEVINE LEAVES,  
<sup>3</sup>/<sub>4</sub>" shown, approx. H10"  
Curve as per template.



255 WOODGRAIN, <sup>5</sup>/<sub>8</sub>" Solid and <sup>7</sup>/<sub>8</sub>" Solid only, 3"P Brackets included, Birds (#929, Left or Right) at additional charge, approx. H9"



256 GRAPEVINE CURVED,  
<sup>3</sup>/<sub>4</sub>" Solid, 3"P Brackets included,  
approx. H8"



256B GRAPEVINE,  
<sup>3</sup>/<sub>4</sub>" Solid, 3"P Brackets included,  
approx. H8"  
Curve as per template.

<sup>1</sup>/<sub>2</sub>" to 2" Round Hollow Rods included in Price for Product # 254, 254B. Brackets to be ordered separately for Product # 252, 253, 254, 254B.

# Burgundy Collection

## Hand Crafted Decorative Rods

A template, as applicable, must be provided for production purposes.

**257 ROSEVINE LEAVES**  
 $\frac{1}{2}$ " Solid, 3" P Brackets included, approx. 116"



Measurements are based from the outside of the left socket to the outside of the right socket.



**257B (BENT) ROSEVINE LEAVES**  
 $\frac{1}{2}$ " Solid 3" P Brackets included.



**264 ROD WITH RETURN**  
 Standard Projection 3" & 6".  
 Round Smooth Rod only.



**264D DECORATIVE ROD**  
 $1\frac{1}{2}$ " DIA WITH RETURN  
 Approx. 110"



**280 ROMAN**, overall length 78", approx. 117 $\frac{1}{2}$ " above the Rod, Standard Projection available 3" & 6".



**281 ROMAN**, overall length 52", approx. 117 $\frac{1}{2}$ " above the Rod, Standard Projection available 3" & 6".



**282 SPANISH**, overall length 78", approx. 117 $\frac{1}{2}$ " above the Rod, Standard Projection available 3" & 6".



**283 SPANISH**, overall length 52", approx. 117 $\frac{1}{2}$ " above the Rod, Standard Projection available 3" & 6".



**284 TWINE BRANCH**  
 Available in any length,  
 approx. 117 $\frac{1}{2}$ " above Rod w/o Bird  
 Standard Projection available 3" & 6"  
 Birds (#929) and Finials (#954) at additional charge.



**285 TWINE BRANCH**  
 Available in any length,  
 approx. 117 $\frac{1}{2}$ " above Rod w/o Bird  
 Shown as By Pass System  
 Standard Projection available 3" & 6"  
 Birds (#929) and Finials (#954) at additional charge.

$\frac{1}{2}$ " to 2" Round Hollow Rods included in Price for Product # 264, 264D, 280, 281, 282, 283, 284, 285. Finials and Rings to be ordered separately.

...vineyards, glades and forests!

# Mediterranean Collection

## Lightweight Decorative Crowns

Mounting options include Flush, Wood Duster Bracket and Wall Bracket P3"

4001 SERVENA  
L38" H15"



4002 CASTILLA  
L30" H13"



4003 CAMILLA  
L33½" H8¾"



4004 SOFIA  
L28¼" H4"



4005 MALLORCA  
L29½" H14¾"



4006 VALENCIA  
L29½" H11"



4007 MINERVA  
L22" H10"



4008 ISABELLE  
L37½" H19½"



4009 ASHA  
L27" H14"

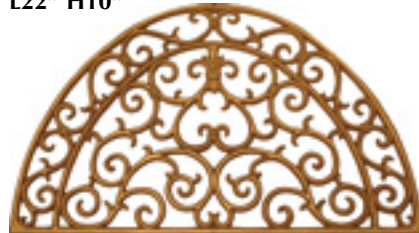

4010 SEVILLE  
L26½" H15½"



4011 MORNING GLORY  
L45½" H12½"

# Vienna Collection

## Decorative Scrolls

All measurements are from tip to tip.

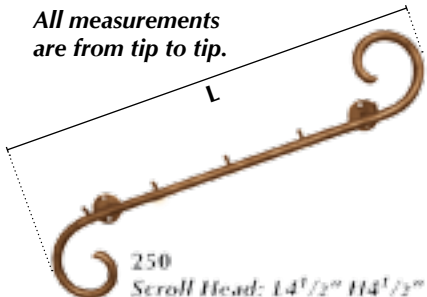

250  
Scroll Head: L4½" H4½"  
⅝" Solid, min. length 16"  
Shown as left.  
Knobs on front side.



266  
Bottom Scroll Head: L7½" H7"  
Top Scroll Head: L2½" H3½"  
min. length 17", max. length 48".  
Shown as left. Knobs on back side.



267  
Scroll Head: L7½" H7"  
min. length 27", max. length 48".  
Shown as left. Knobs on back side.

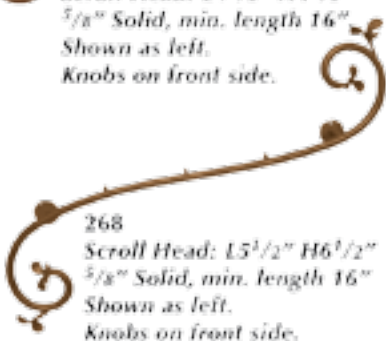

268  
Scroll Head: L5½" H6½"  
⅝" Solid, min. length 16"  
Shown as left.  
Knobs on front side.



270  
Scroll Head: H5½"  
⅝" Solid, min. length 16".  
Knobs on front side.



269  
Scroll Head: L4½" H6½"  
⅝" Solid, min. length 16".  
Shown as right.  
Knobs on front side.

# Renaissance Collection

## Lightweight Decorative Cornices

9125 CATHEDRAL L26<sup>3</sup>/<sub>2</sub>" H110" PER PANEL (Shown with 3 panels)



9126 PONTALBA L25<sup>3</sup>/<sub>4</sub>" H8<sup>1</sup>/<sub>2</sub>" PER PANEL (Shown with 3 panels)



9127 NEW ORLEANS L27<sup>1</sup>/<sub>2</sub>" H8<sup>1</sup>/<sub>2</sub>" PER PANEL (Shown with 3 panels)



9128 GOTHIC L27<sup>3</sup>/<sub>4</sub>" H111" PER PANEL (Shown with 3 panels)



9129 FLORENCE L27<sup>3</sup>/<sub>4</sub>" H111<sup>1</sup>/<sub>4</sub>" PER PANEL (Shown with 3 panels)



9130  
RETURNS WITH  
MOUNTING  
PLATES UP TO 6"



Decorative Cornice shown with Returns  
and Mounting Plates, 6" Projection  
(Shown with 1 panel)

... classy and timeless!

*Tuscany Collection*  
*Lightweight Decorative Metal Cornices*





# Tuscany Collection

## Lightweight Decorative Metal Cornices

NARROW (2<sup>7</sup>/<sub>8</sub>" - 3<sup>3</sup>/<sub>4</sub>" )

8021 ACANTHUS SINGLE H 3<sup>1</sup>/<sub>2</sub>" (Shown in Bronze Vecchio)

8022 ACANTHUS DOUBLE H 7"



8023 TULIP SINGLE H 3<sup>1</sup>/<sub>2</sub>" (Shown in Cherry Gold)

8024 TULIP DOUBLE H 7"



8034 SPRING LEAF SINGLE H 3<sup>3</sup>/<sub>4</sub>" (Shown in Gold Antique White)

8035 SPRING LEAF DOUBLE H 7<sup>1</sup>/<sub>2</sub>"



8026 BAROQUE SINGLE H 3<sup>3</sup>/<sub>8</sub>" (Shown in Rusty)

8027 BAROQUE DOUBLE H 6<sup>3</sup>/<sub>4</sub>"



8036 SEA SHORE SINGLE H 3<sup>3</sup>/<sub>4</sub>" (Shown in Cherry Gold)



8028 EMBOSSED SINGLE H 2<sup>7</sup>/<sub>8</sub>" (Shown in Antique Bronze)

8029 EMBOSSED DOUBLE H 5<sup>3</sup>/<sub>4</sub>"



8055 INFINITE GEOMETRY SINGLE H 3<sup>5</sup>/<sub>8</sub>" (Shown in Antique Gold)

8056 INFINITE GEOMETRY DOUBLE H 7<sup>1</sup>/<sub>4</sub>"



8030 BUD BRANCH SINGLE H 3<sup>1</sup>/<sub>2</sub>" (Shown in Antique Gold)

8031 BUD BRANCH DOUBLE H 7"



8057 CLASSIC SINGLE H 3<sup>1</sup>/<sub>2</sub>" (Shown in Burnt Gold)

8058 CLASSIC DOUBLE H 7"



8032 SPANISH SCROLL SINGLE H 3<sup>1</sup>/<sub>2</sub>" (Shown in Antique Bronze)

8033 SPANISH SCROLL DOUBLE H 7"



8059 ROYAL ROAD SINGLE H 3<sup>1</sup>/<sub>2</sub>" (Shown in Autumn)

8060 ROYAL ROAD DOUBLE H 7"



# Tuscany Collection

## Lightweight Decorative Metal Cornices

MEDIUM (4" - 5½")

8037 BASKET WEAVE H 5½" (Shown in Rich Gold)

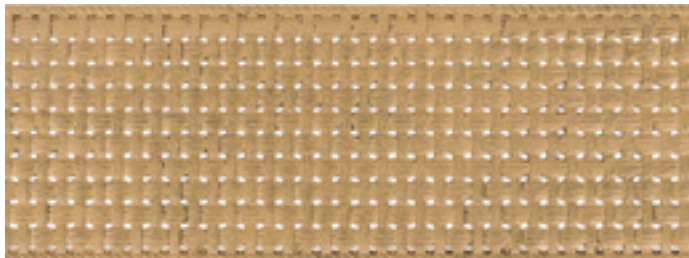

8067 OLIVE BRANCHES SINGLE H 4¾" (Shown in Antique Copper)

8068 OLIVE BRANCHES DOUBLE H 8¾"



8061 BAMBOO DELIGHT SINGLE H 4⅛" (Shown in Bronze Patina)

8062 BAMBOO DELIGHT DOUBLE H 8¼"

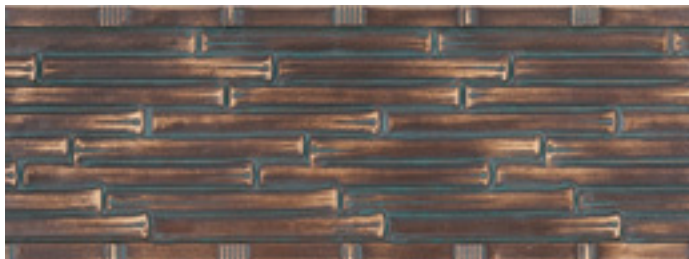

8069 EMBLEM SINGLE H 4¼" (Shown in Sage Gold)

8070 EMBLEM DOUBLE H 8¼"



8063 Sunbursts SINGLE H 4⅛" (Shown in Antique Bronze)

8064 SUNBURSTS DOUBLE H 8¼"



8071 SWIRLS SINGLE H 4⅛" (Shown in Antique White)

8072 SWIRLS DOUBLE H 8¼"



8065 METAL WEAVE SINGLE H 4⅛" (Shown in Soft Pewter)

8066 METAL WEAVE DOUBLE H 8¼"



8073 Windblown SINGLE H 4" (Shown in Antique Copper)

8074 Windblown DOUBLE H 8"



# Tuscany Collection

## Lightweight Decorative Metal Cornices

TALL (6" - 8")

8025 HAMMERED SINGLE H 8" (Shown in Soft Pewter)

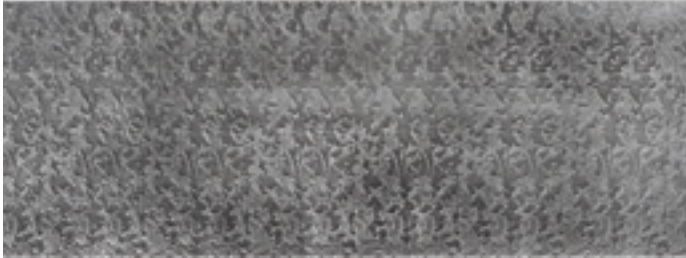

8077 LATTICE WEAVE H 6 1/8" (Shown in Bronze Vecchio)



8075 PYRAMIDS H 6" (Shown in Vecchio Patina)



8079 MOSAICS H 6" (Shown in Versace)



### CORNICE OPTIONS



All Designs can be bent (8044)

# *Clip-A-Crown*

## *Lightweight Decorative Metal Valance Over Blinds*



*“Dress Up Your Blinds”*



### **Great Features**

- Easy to install: Just clips on the existing head rail!
- Lightweight - made from embossed metal.
- Enhance your existing or new blinds.
- Fits both metal and wood blind head rails.
- 21 designs: Traditional, Transitional and Contemporary.
- 35 Iron Art finishes, plus custom colors.
- Custom cut widths.
- 3 Height categories: Narrow, Medium and Tall .
- 3 Mounting styles: 2 with returns.
- Value for design.
- Shipping in 10 business days; Rush shipping available.

# *Clip-A-Crown*

## *Lightweight Decorative Metal Valance Over Blinds*

NARROW (3<sup>3</sup>/<sub>8</sub>" - 3<sup>3</sup>/<sub>4</sub>")

CC8021 ACANTHUS H 3<sup>1</sup>/<sub>2</sub>" (Shown in Bronze Vecchio)



CC8034 SPRING LEAF H 3<sup>3</sup>/<sub>4</sub>" (Shown in Gold Antique White)



CC8023 TULIP H 3<sup>1</sup>/<sub>2</sub>" (Shown in Cherry Gold)



CC8036 SEA SHORE H 3<sup>3</sup>/<sub>4</sub>" (Shown in Cherry Gold)



CC8026 BAROQUE H 3<sup>3</sup>/<sub>8</sub>" (Shown in Rusty)



CC8055 INFINITE GEOMETRY H 3<sup>3</sup>/<sub>8</sub>" (Shown in Antique Gold)



CC8030 BUD BRANCH H 3<sup>1</sup>/<sub>2</sub>" (Shown in Antique Gold)



CC8057 CLASSIC H 3<sup>1</sup>/<sub>2</sub>" (Shown in Burnt Gold)



CC8032 SPANISH SCROLL H 3<sup>1</sup>/<sub>2</sub>" (Shown in Antique Bronze)



CC8059 ROYAL ROAD H 3<sup>1</sup>/<sub>2</sub>" (Shown in Autumn)

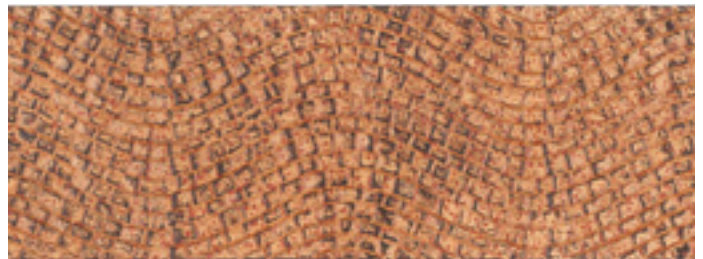

# *Clip-A-Crown*

## *Lightweight Decorative Metal Valance Over Blinds*

MEDIUM (4" - 4<sup>3</sup>/<sub>8</sub>" )

CC8061 BAMBOO DELIGHT H 4<sup>1</sup>/<sub>8</sub>" (Shown in Bronze Patina)

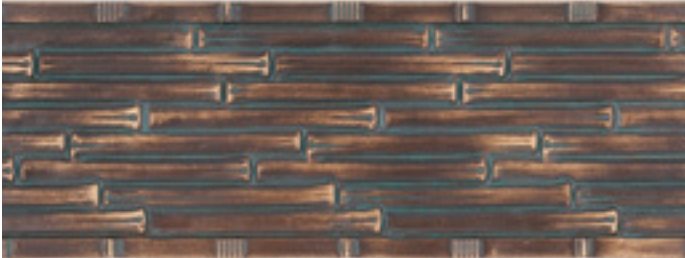

CC8069 EMBLEM H 4<sup>1</sup>/<sub>4</sub>" (Shown in Sage Gold)



CC8063 Sunbursts H 4<sup>1</sup>/<sub>8</sub>" (Shown in Antique Bronze)



CC8071 SWIRLS H 4<sup>1</sup>/<sub>8</sub>" (Shown in Antique White)



CC8065 METAL WEAVE H 4<sup>1</sup>/<sub>8</sub>" (Shown in Soft Pewter)



CC8073 Windblown H 4" (Shown in Antique Copper)



CC8067 OLIVE BRANCHES H 4<sup>3</sup>/<sub>8</sub>" (Shown in Antique Copper)



# Clip-A-Crown

## Lightweight Decorative Metal Valance Over Blinds

TALL (6" - 6 1/8")

CC8075 PYRAMIDS H 6" (Shown in Vecchio Patina)



CC8077 LATTICE WEAVE H 6 1/8" (Shown in Bronze Vecchio)

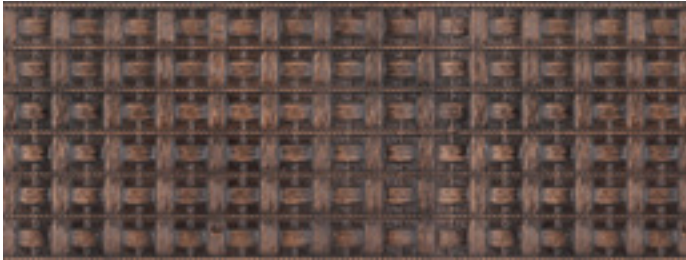

CC8079 MOSAICS H 6" (Shown in Versace)



### BACK VIEW (Same finish as front of valance.)



Narrow (One Wood Slat)



Medium (One Wood Slat)



Tall (Two Wood Slats)

### MOUNTING OPTIONS

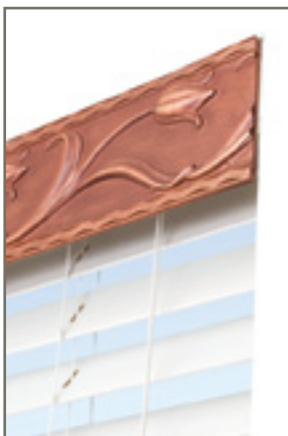

Inside Mount

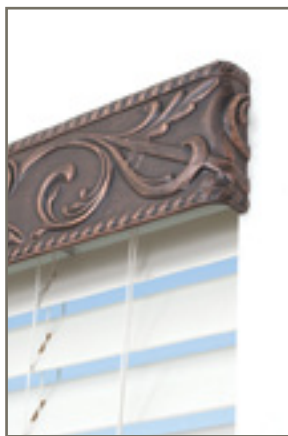

Inside Mount Plus Frame



Outside Mount

# Manual and Motorized Traversing



Orion's traversing systems come with many great features, plus plenty of options to choose from.

When using traversing, draperies will open and close easier than traditional rod and ring combinations through the use of heavy-duty glides, tracks and pulleys. With these heavy-duty systems you can safely hang up to 62 pounds of drapes on a 16 foot track; great in these days of lining and interlining. Single or double track systems up to 30 feet in length allow for a wide range of drapery styles. Front tracks are available with or without rings.

Our cord or baton drawn traversing collections include Designers' Choice (Iron, Wood, and Italian fascia styles), Tuscany Traversing (lightweight embossed metal rods), and Deco Lite Traversing (lightweight embossed metal panels). All these collections can be motorized with Somfy.

Orion offers nearly 200 different finials and 52 beautiful finishes to compliment your traversing system. You can even do your own custom finish. With so many options to choose from, you're sure to create that perfect design!

## DESIGNERS' CHOICE TRAVERSING RODS

Single and Double Traversing Sets  
in Iron, Wood and Italian Fascia Styles.

***pages 42-45***

## TUSCANY TRAVERSING

Single and Double Traversing Sets with  
Lightweight Embossed Metal Rod Designs.

***pages 46-48***

## TRAVERSING ACCESSORIES

Rings, Batons, Glides, Etc.

***page 49***



# *Manual and Motorized Traversing*

DECO LITE TRAVERSING  
Single and Double Traversing Sets with  
Lightweight Embossed Metal Panel Designs.

***pages 50-51***

TRAVERSING WITH  
SOMFY MOTORIZATION  
Motorization for Traversing Collections.

***pages 52-55***

SOMFY ACCESSORIES  
Control Options, Rings, Glides, Etc.

***pages 56-57***



# \*Designers' Choice Traversing Rods

## IRON - SINGLE TRAVERSING RODS

Available in 1½" and 2" diameters.



**Shown:**  
**Finial:** 946-Small 2" Diameter  
**Rod:** 1½" Round Traversing Rod  
**Ring:** IT350TR - Smooth Ring  
**Set Finish:** Rusty  
**Track Finish:** Black  
**Draw Opening:** Center Open

Set: ITRR-S

Also available in 3" diameter

Available in Iron Art™ or Italian Collection Finishes.



**Shown:**  
**Finial:** 947L  
**Rod:** 2" Square Traversing Rod  
**Ring:** IT352TR - Square Ring  
**Set Finish:** Soft Pewter  
**Track Finish:** Black  
**Draw Opening:** Center Open

Set: ITSQ-S

Available in Iron Art™ or Italian Collection Finishes.



**Shown:**  
**Finial:** 946H-Medium 3" Diameter  
**Rod:** 2" Round Hammered Traversing Rod  
**Ring:** IT356TR - Hammered Ring  
**Set Finish:** Bronze Patina  
**Track Finish:** Antique Bronze  
**Draw Opening:** Center Open

Set: ITRH-S

Also available in 3" diameter

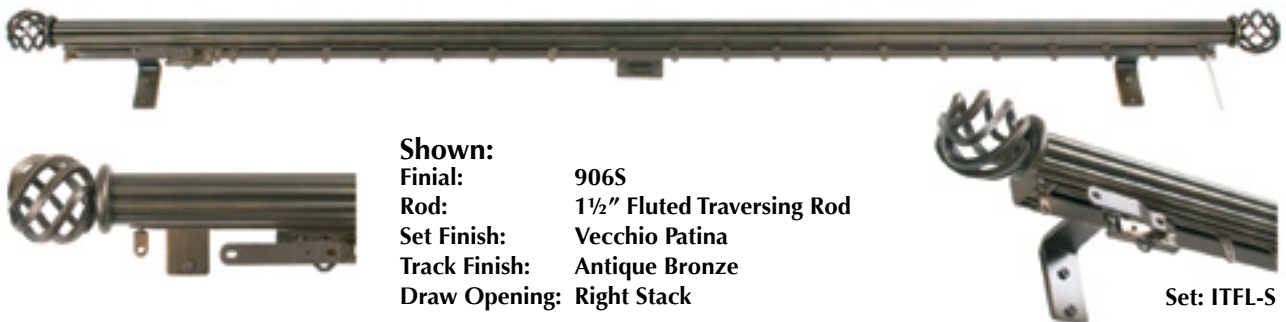

**Shown:**  
**Finial:** 906S  
**Rod:** 1½" Fluted Traversing Rod  
**Set Finish:** Vecchio Patina  
**Track Finish:** Antique Bronze  
**Draw Opening:** Right Stack

Set: ITFL-S

# \*Designers' Choice Traversing Rods

## IRON - DOUBLE TRAVERSING RODS

Available: Front Rod in 1½" and 2" diameters. Back Rod in 1¼" diameter only.



**Shown:**  
**Finial:** 946-Large 4" Diameter  
**Front Rod:** 3" Round Traversing Rod  
**Back Rod:** Track Only  
**Ring:** IT350TR - Smooth Ring  
**Set Finish:** Rich Gold  
**Track Finish:** Gold  
**Draw Opening:** Right Stack  
 Available in Iron Art™ or Italian Collection Finishes.

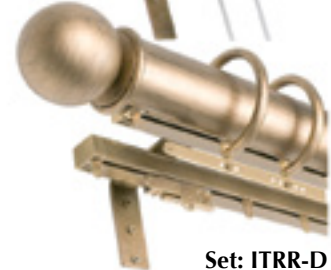

Set: ITRR-D

Also available in 3" diameter



**Shown:**  
**Finial:** 7006L  
**Front Rod:** 2" Square Traversing Rod  
**Back Rod:** 1¼" Square Traversing Rod  
**Ring:** IC352TR - Square Ring  
**Set Finish:** Brushed Nickel  
**Track Finish:** White  
**Draw Opening:** Center Open  
 Available in Iron Art™ or Italian Collection Finishes.



Set: ICSQ-D

\*Italian Collection Iron Traversing Set



**Shown:**  
**Finial:** 908  
**Front Rod:** 2" Round Hammered Traversing Rod  
**Back Rod:** 1¼" Round Hammered Traversing Rod  
**Ring:** IT356TR - Hammered Ring  
**Set Finish:** Burnt Gold  
**Track Finish:** Antique Bronze  
**Draw Opening:** Center Open



Set: ITRH-D

Also available in 3" diameter



**Shown:**  
**Finial:** 903  
**Front Rod:** 2" Fluted Traversing Rod  
**Back Rod:** 1¼" Fluted Traversing Rod  
**Set Finish:** Cherry Gold  
**Track Finish:** Gold  
**Draw Opening:** Left Stack



Set: ITFL-D

\*Automatically includes heavy duty track at no extra charge. Finials, rings, and batons sold separately. Glides are available in white, black, antique bronze or gold. • All end pulleys are available only in white.

# \*Designers' Choice Traversing Rods

## WOOD - SINGLE TRAVERSING RODS

Available in 2", 2 1/4" and 3" diameters.



**Shown:**  
**Finial:** 5025  
**Rod:** 2 1/4" Round Traversing Rod  
**Ring:** WT5047TR - Smooth Ring  
**Set Finish:** Walnut  
**Track Finish:** Black  
**Draw Opening:** Center Open

Set: WTRN-S

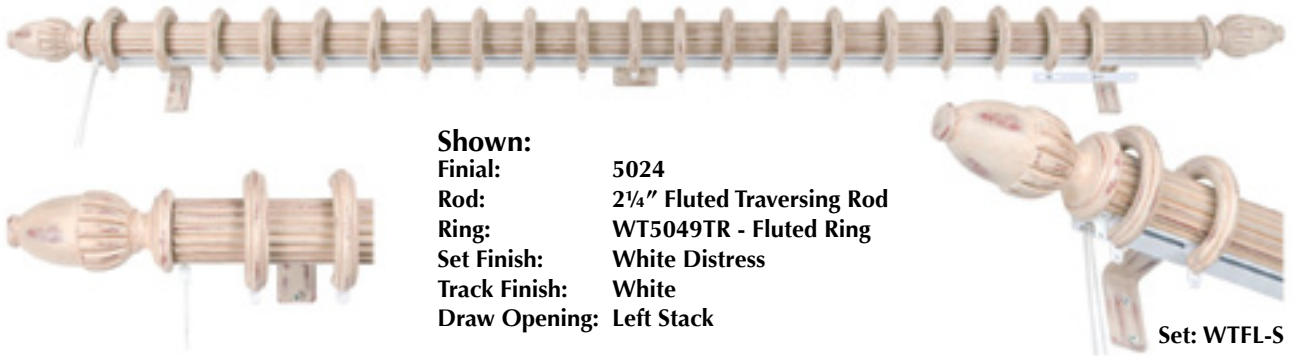

**Shown:**  
**Finial:** 5024  
**Rod:** 2 1/4" Fluted Traversing Rod  
**Ring:** WT5049TR - Fluted Ring  
**Set Finish:** White Distress  
**Track Finish:** White  
**Draw Opening:** Left Stack

Set: WTFL-S



**Shown:**  
**Finial:** 5032  
**Rod:** 3" Rope Traversing Rod  
**Set Finish:** Natural  
**Track Finish:** White  
**Draw Opening:** Left Stack

Set: WTRP-S

# \*Designers' Choice Traversing Rods

## WOOD - DOUBLE TRAVERSING RODS

Available: Front Rod in 2", 2 1/4" and 3" diameters. Back Rod in 1 3/8" diameter only.



**Shown:**  
**Finial:** 5052  
**Front Rod:** 3" Smooth Traversing Rod  
**Back Rod:** Track Only  
**Ring:** WT5047TR - Smooth Ring  
**Set Finish:** Mahogany  
**Track Finish:** Black  
**Draw Opening:** Right Stack

Set: WTRN-D



**Shown:**  
**Finial:** 5020  
**Front Rod:** 2 1/4" Fluted Traversing Rod  
**Back Rod:** 1 3/8" Fluted Traversing Rod  
**Ring:** WT5049TR - Fluted Ring  
**Set Finish:** Light Cherry  
**Track Finish:** Black  
**Draw Opening:** Center Open

Set: WTFL-D



**Shown:**  
**Front Rod:** 3" Rope Traversing Rod with Miter Return\*\*  
**Back Rod:** Track Only  
**Ring:** WT5047TR - Smooth Ring  
**Set Finish:** Sun Oak  
**Track Finish:** White  
**Draw Opening:** Center Open

Set: WTRP-D

\*\*Miter Return at additional charge. Refer to product #WT307MR in Price List.

\*Automatically includes heavy duty track at no extra charge. Finials, rings, and batons sold separately. Glides are available in white, black, antique bronze or gold. • All end pulleys are available only in white.

# *Tuscany Traversing Collection*

## *Lightweight Embossed Metal Rods*

### SAMPLE MANUAL CONFIGURATIONS: CORDED



#### SINGLE TUSCANY TRAVERSING

Finial: 947                      Rod Fascia Design: TT8055 Infinite Geometry  
 Set Finish: Antique Copper      Draw Opening: Right Stack



#### SINGLE TUSCANY TRAVERSING WITH RINGS

Finial: 903                      Rod Fascia Design: TT8023 Tulip  
 Set Finish: Antique White      Draw Opening: Right Stack



#### DOUBLE TUSCANY TRAVERSING

Finial: 414                      Rod Fascia Design: TT8021 Acanthus  
 Set Finish: Antique Bronze      Draw Opening: Center Open



#### DOUBLE TUSCANY TRAVERSING WITH RINGS

Finial: 418                      Rod Fascia Design: TT8034 Spring Leaf  
 Set Finish: Bronze Patina      Draw Opening: Center Open



# *Tuscany Traversing Collection*

## *Lightweight Embossed Metal Rods*

### FASCIA DESIGNS

**TT8021 ACANTHUS H 2½"** (Shown in Bronze Vecchio)



**TT8023 TULIP H 2½"** (Shown in Cherry Gold)



**TT8034 SPRING LEAF H 2¾"** (Shown in Gold Antique White)



**TT8026 BAROQUE H 2¾"** (Shown in Rusty)



**TT8036 SEA SHORE H 2¾"** (Shown in Cherry Gold)



**TT8028 EMBOSSED H 1⅞"** (Shown in Antique Bronze)



**TT8055 INFINITE GEOMETRY H 2⅝"** (Shown in Antique Gold)



**TT8030 BUD BRANCH H 2½"** (Shown in Antique Gold)



**TT8057 CLASSIC H 2½"** (Shown in Burnt Gold)



**TT8032 SPANISH SCROLL H 2½"** (Shown in Antique Bronze)



**TT8059 ROYAL ROAD H 2½"** (Shown in Autumn)



# Tuscany Traversing Collection

## Lightweight Embossed Metal Rods

### SAMPLE MOTORIZED CONFIGURATIONS



SINGLE TUSCANY TRAVERSING WITH SOMFY MOTORIZATION

Finial: 414

Rod Fascia Design: TT8021 Acanthus

Set Finish: Antique Bronze

Draw Opening: Center Open

### TUSCANY TRAVERSING OPTIONS

#### TRACK SYSTEMS

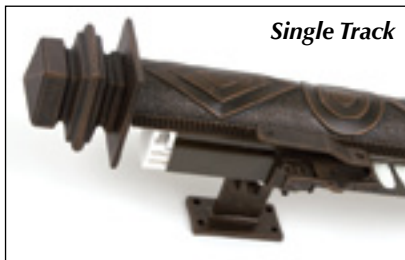

#### RING OPTIONS



#### BENT OPTION *(Rod may be bent or curved.)*





# Traversing Accessories

## HEAVY DUTY BRACKETS

WALL MOUNT  
*End Brackets*



**1048EBS**  
SINGLE  
END BRACKET  
*Vertical back plate*

**1049EBD**  
DOUBLE  
END BRACKET  
*Vertical back plate*

WALL MOUNT  
*Support Brackets*



**1050SBS**  
SINGLE SUPPORT  
BRACKET  
*Horizontal back plate*

**1051SBD**  
DOUBLE SUPPORT  
BRACKET  
*Horizontal back plate*

CEILING MOUNT  
*End & Support Brackets*



**1052CBS**  
SINGLE BRACKET  
*Horizontal top plate*

**1053CBD**  
DOUBLE BRACKET  
*Horizontal top plate*

TRACKS, PINCH PLEAT GLIDES &  
RETURN HOOKS AVAILABLE IN:

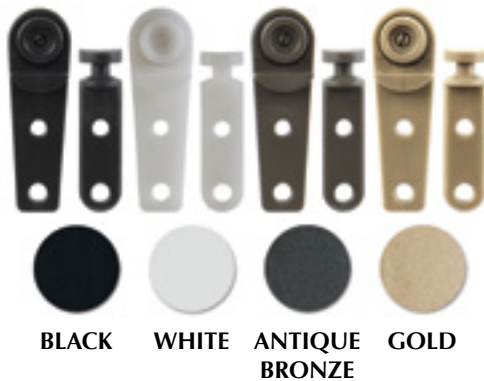

BLACK

WHITE

ANTIQUE  
BRONZE

GOLD

RIPPLEFOLD GLIDES  
AVAILABLE IN WHITE.

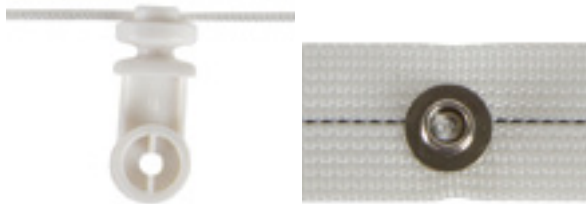

## C-RINGS

IRON

ITALIAN

WOOD



**IT350TR** **IT352TR** **IT356TR** **IC350TR** **IC352TR** **WT5047TR** **WT5049TR**  
ROUND SQUARE HAMMERED ROUND SQUARE SMOOTH FLUTED

## BATONS



**IT1016BT**  
IRON BATON  
1/2" DIA.  
Available from  
48" - 72"

**IT1020BT**  
IRON BATON  
WITH WOODEN  
HANDLE  
1/2" DIA.  
Available from  
48" - 72"

# *Deco Lite Traversing*

## *Lightweight Embossed Metal Panels*

### SAMPLE MANUAL CONFIGURATIONS: CORDED



**SINGLE MANUAL TRAVERSING**  
Set Finish: Bronze Vecchio  
Fascia Design: DT8021 Acanthus  
Draw Opening: Right Stack



**DOUBLE MANUAL TRAVERSING**  
Set Finish: Naturelle  
Fascia Design: DT8055 Infinite Geometry  
Draw Opening: Right Stack

### SAMPLE MOTORIZED CONFIGURATIONS



**SINGLE MOTORIZED TRAVERSING**  
Set Finish: Golden Oak  
Fascia Design: DT8059 Royal Road  
Draw Opening: Right Stack



**DOUBLE MOTORIZED TRAVERSING**  
Set Finish: Antique Gold  
Fascia Design: DT8034 Spring Leaf  
Draw Opening: Right Stack

# Deco Lite Traversing Lightweight Embossed Metal Panels

## FASCIA DESIGNS

DT8021 ACANTHUS H 3½" (Shown in Bronze Vecchio)



DT8023 TULIP H 3½" (Shown in Cherry Gold)



DT8034 SPRING LEAF H 3¾" (Shown in Gold Antique White)



DT8026 BAROQUE H 3⅝" (Shown in Rusty)



DT8036 SEA SHORE H 3¾" (Shown in Cherry Gold)



DT8028 EMBOSSED H 2⅞" (Shown in Antique Bronze)



DT8055 INFINITE GEOMETRY H 3⅝" (Shown in Antique Gold)



DT8030 BUD BRANCH H 3½" (Shown in Antique Gold)



DT8057 CLASSIC H 3½" (Shown in Burnt Gold)



DT8032 SPANISH SCROLL H 3½" (Shown in Antique Bronze)



DT8059 ROYAL ROAD H 3½" (Shown in Autumn)



## DECO LITE TRAVERSING OPTIONS

### TRACK SYSTEMS

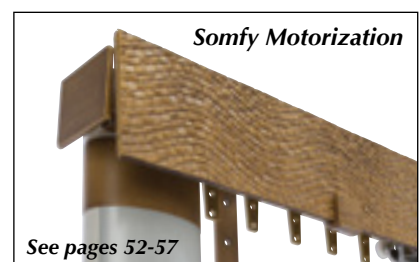
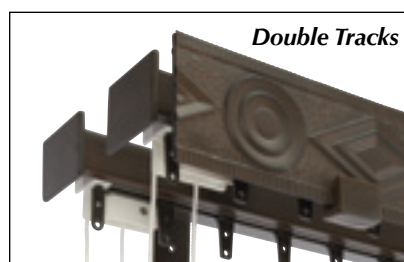

See pages 52-57

# *Traversing with Somfy Motorization*



**TRAVERSING WITH SOMFY**  
CHOOSE. TOUCH. RELAX.™

# *Traversing with Somfy Motorization*

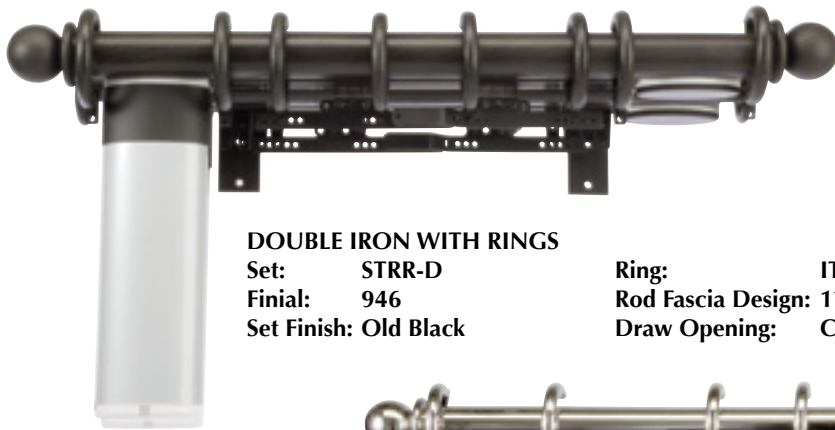

## DOUBLE IRON WITH RINGS

Set: STRR-D  
 Finial: 946  
 Set Finish: Old Black

Ring: IT350TR - Round Traversing Ring  
 Rod Fascia Design: 1½" DIA. Round Traversing Rod  
 Draw Opening: Center Open



## DOUBLE ITALIAN WITH RINGS

Set: STIQ-D  
 Finial: 946  
 Set Finish: Polished Chrome

Ring: IT350TR - Round Traversing Ring  
 Rod Fascia Design: 1½" DIA. Round Traversing Rod  
 Draw Opening: Center Open

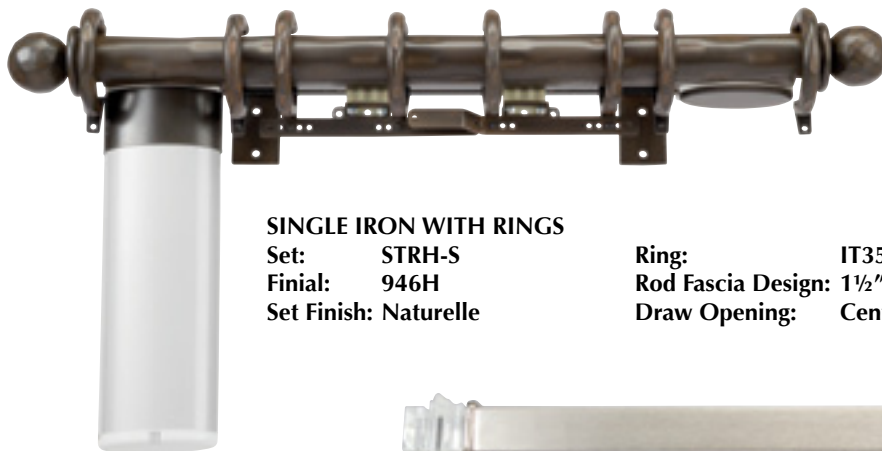

## SINGLE IRON WITH RINGS

Set: STRH-S  
 Finial: 946H  
 Set Finish: Naturelle

Ring: IT356TR - Hammered Traversing Ring  
 Rod Fascia Design: 1½" DIA. Round Hammered Traversing Rod  
 Draw Opening: Center Open



## SINGLE ITALIAN WITHOUT RINGS

Set: STIQ-S  
 Finial: 782  
 Set Finish: Brushed Nickel

Rod Fascia Design: 2" DIA. Square Traversing Rod  
 Draw Opening: Center Open



## SINGLE IRON WITHOUT RINGS

Set: STSQ-S  
 Finial: 947L  
 Set Finish: Oil Rubbed Bronze

Rod Fascia Design: 2" DIA. Square Traversing Rod  
 Draw Opening: Center Open

# Traversing with Somfy Motorization



## SINGLE WOOD WITHOUT RINGS

Set: STSM-S

Finial: 5028

Set Finish: Aged Pewter

Rod Fascia Design: 2 1/4" DIA. Smooth Traversing Rod

Draw Opening: Right Stack



## DOUBLE WOOD WITHOUT RINGS

Set: STWF-D

Finial: 5024

Set Finish: Mahogany

Rod Fascia Design: 2 1/4" DIA. Fluted Traversing Rod

Draw Opening: Left Stack



## SINGLE TUSCANY TRAVERSING WITHOUT RINGS

Set: TTST-S

Finial: 906S

Set Finish: Burnt Gold

Rod Fascia Design: TT8028 Embossed

Draw Opening: Center Open



## TUSCANY TRAVERSING CURVED ROD

Set: TTST-S with curve (*Additional charges apply*)

Finial: 990

Set Finish: Golden Oak

Rod Fascia Design: TT8030 Bud Branch

Draw Opening: Center Open



## TRACK ONLY

Set: ST35-S (for 35 RTS Motor) / ST60E-S (for 60e RTS Motor)

Draw Opening: Right Stack

# Traversing with Somfy Motorization

## TRAVERSING WITH SOMFY OPTIONS

### FASCIA OPTIONS

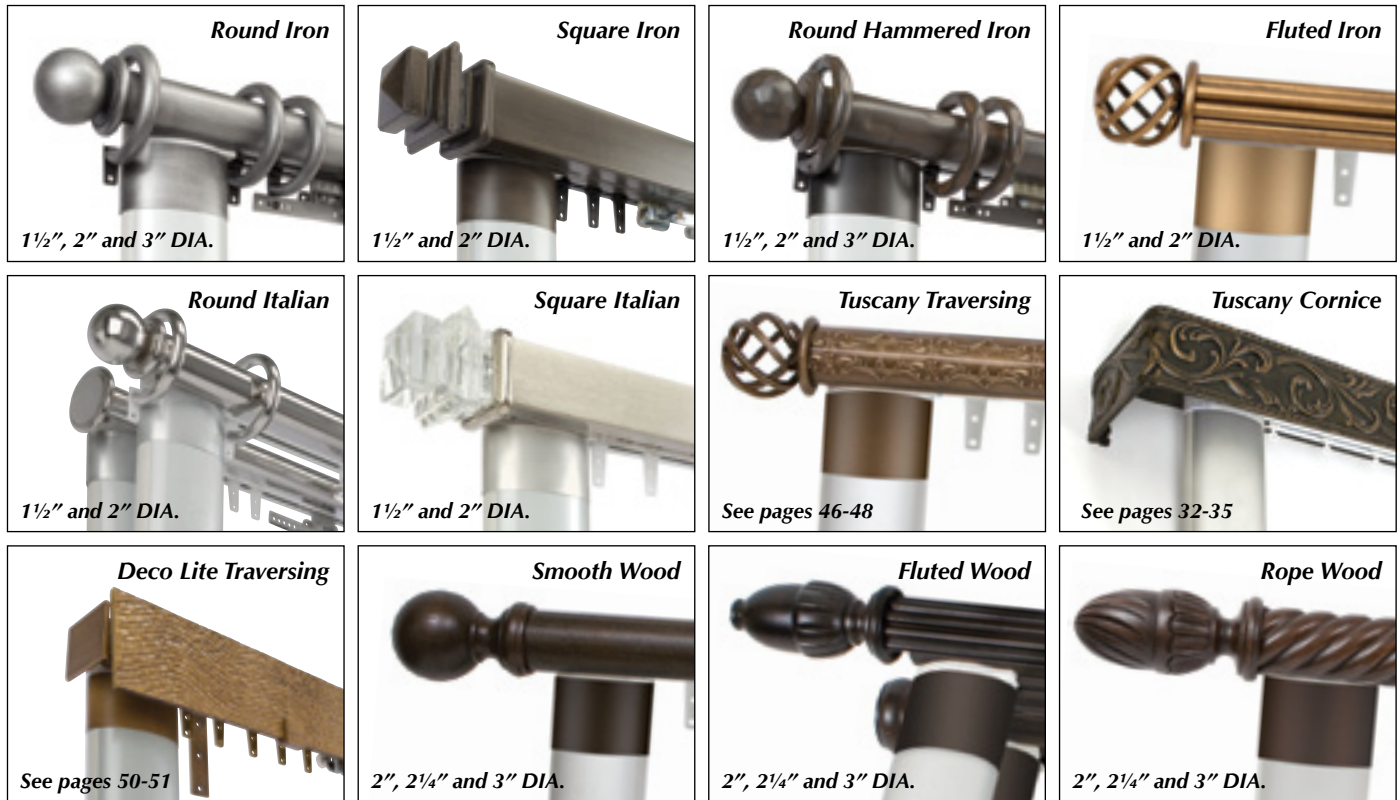

### TRACK SYSTEMS



### RING OPTIONS

### ADDITIONAL INFORMATION

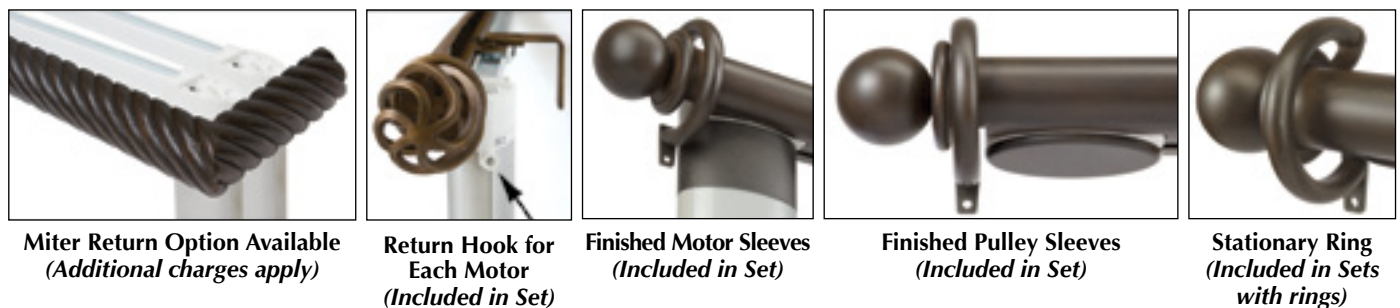

# Traversing with Somfy Motorization

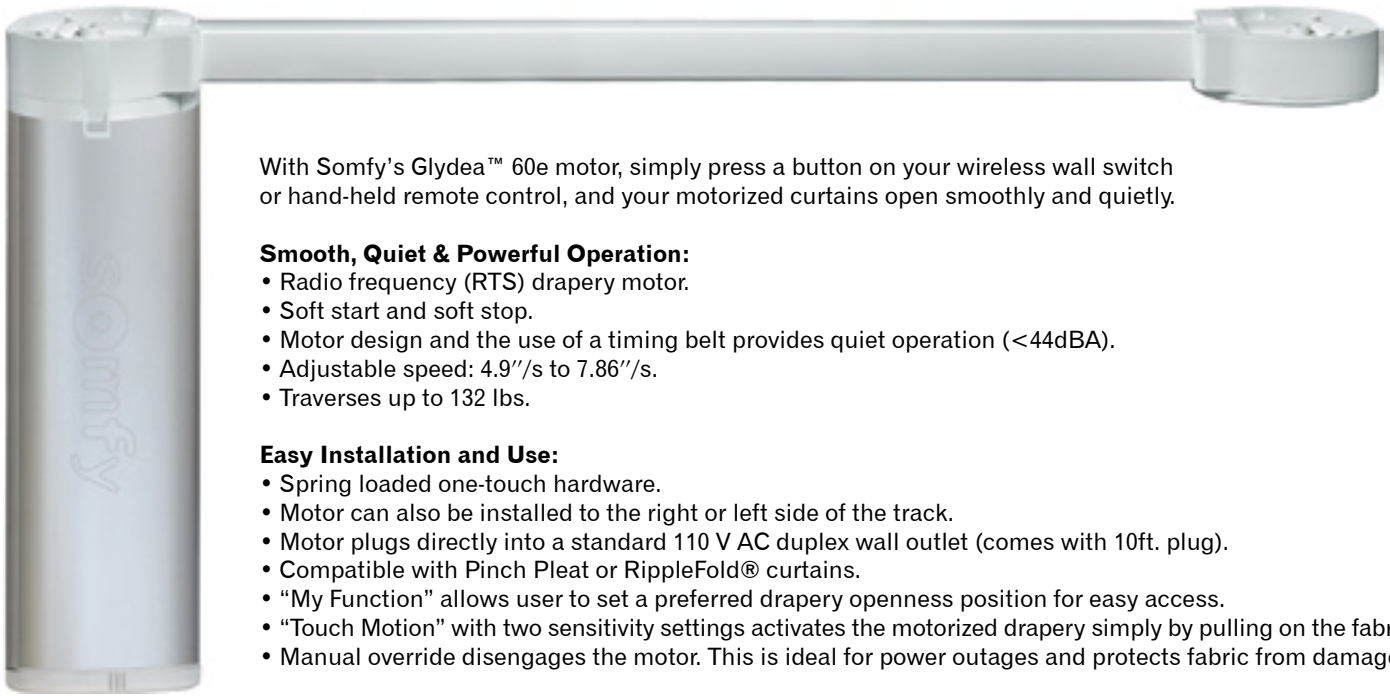

With Somfy's Glydea™ 60e motor, simply press a button on your wireless wall switch or hand-held remote control, and your motorized curtains open smoothly and quietly.

### Smooth, Quiet & Powerful Operation:

- Radio frequency (RTS) drapery motor.
- Soft start and soft stop.
- Motor design and the use of a timing belt provides quiet operation (<44dBa).
- Adjustable speed: 4.9"/s to 7.86"/s.
- Traverses up to 132 lbs.

### Easy Installation and Use:

- Spring loaded one-touch hardware.
- Motor can also be installed to the right or left side of the track.
- Motor plugs directly into a standard 110 V AC duplex wall outlet (comes with 10ft. plug).
- Compatible with Pinch Pleat or RippleFold® curtains.
- "My Function" allows user to set a preferred drapery openness position for easy access.
- "Touch Motion" with two sensitivity settings activates the motorized drapery simply by pulling on the fabric.
- Manual override disengages the motor. This is ideal for power outages and protects fabric from damage.

## CONTROL OPTIONS

### DECOFLEX WIREFREE RTS WALL SWITCHES

#### White Finish



**STSW1-WH**  
1 Track  
1 Channel

**STSW5-WH**  
1-5 Tracks  
5 Channels

#### Ivory Finish



**STSW1-IV**  
1 Track  
1 Channel

**STSW5-IV**  
1-5 Tracks  
5 Channels

#### Black Finish



**STSW1-BL**  
1 Track  
1 Channel

**STSW5-BL**  
1-5 Tracks  
5 Channels

### SOMFY SUNIS INDOOR (RTS) WIREFREE SENSORS



**SUNIS-SUN**  
Sun Sensor Only  
unlimited tracks  
multi-channel

**SUNIS-TMP**  
Sun & Temp. Sensor  
unlimited tracks  
multi-channel

### TELIS 1 CHRONIS RTS Single Channel Zone Control & Programmable Timer



**STRP1-SS**  
1 Track / 1 Channel  
Silver Star Finish

### TELIS RTS REMOTE CONTROL

#### Pure Finish



**STRP1-PR**  
1 Track  
1 Channel

**STRP5-PR**  
1-5 Tracks  
5 Channels

#### Silver Finish



**STRP1-SL**  
1 Track  
1 Channel

**STRP5-SL**  
1-5 Tracks  
5 Channels

#### Lounge Finish



**STRP1-LO**  
1 Track  
1 Channel

**STRP5-LO**  
1-5 Tracks  
5 Channels

### DECOFLEX TABLE TOP ACCESSORIES

#### Black Finish



**STTABLE-BL**  
with STSW1-BL

#### Silver Finish



**STTABLE-SL**  
with STSW1-BL



# Traversing with Somfy Motorization

## HEAVY DUTY BRACKETS

### WALL MOUNT End Brackets



**1048EBSS**  
SINGLE  
END BRACKET  
*Vertical back plate*

**1049EBSD**  
DOUBLE  
END BRACKET  
*Vertical back plate*

### WALL MOUNT Support Brackets



**1050SBSS**  
SINGLE SUPPORT  
BRACKET  
*Horizontal back plate*

**1051BSD**  
DOUBLE SUPPORT  
BRACKET  
*Horizontal back plate*

### CEILING MOUNT End & Support Brackets



**1052CBSS**  
SINGLE BRACKET  
*Horizontal top plate*

**1053CBSD**  
DOUBLE BRACKET  
*Horizontal top plate*

## TRACKS, PINCH PLEAT GLIDES & RETURN HOOKS AVAILABLE IN:

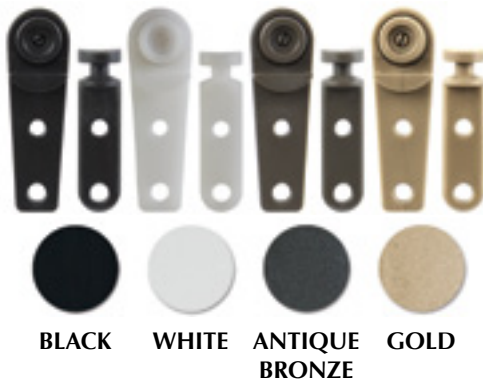

**BLACK**   **WHITE**   **ANTIQUE BRONZE**   **GOLD**

## RIPPLEFOLD GLIDES AVAILABLE IN WHITE.

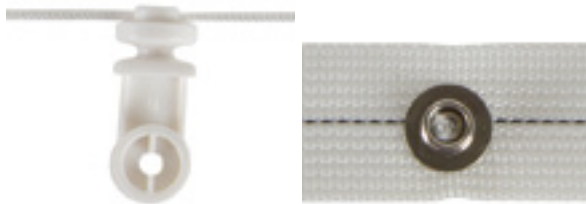

## C-RINGS

### IRON

### ITALIAN

### WOOD



**IT350STR** **IT352STR** **IT356STR** **IC350STR** **IC352STR** **WT5047STR** **WT5049STR**  
ROUND SQUARE HAMMERED ROUND SQUARE SMOOTH FLUTED

## BATONS



**IT1016BT**  
IRON BATON  
1/2" DIA.  
Available from  
48" - 72"

**IT1020BT**  
IRON BATON  
WITH WOODEN  
HANDLE  
1/2" DIA.  
Available from  
48" - 72"

# Italian Collection

## Metal Plated Iron Drapery Hardware

All Finials: Interior fit only. Available in 3/4", 1" and 1 1/4" diameter only.



Options  
 7002 1 1/2" DIA  
 7003\* 2" DIA

Finial: 7002  
 Finish: Brushed Nickel

1 1/2" DIA



Finial: 7001  
 Finish: Brushed Nickel

L 1 3/4" H 1 1/4"



Options  
 7005 L 2" H 1 1/8"  
 7005L\* L 3" H 1 3/4"

Finial: 7005  
 Finish: Brushed Nickel

L 2" H 1 1/8"



Finial: 7004  
 Finish: Polished Chrome

L 2" H 1 1/8"

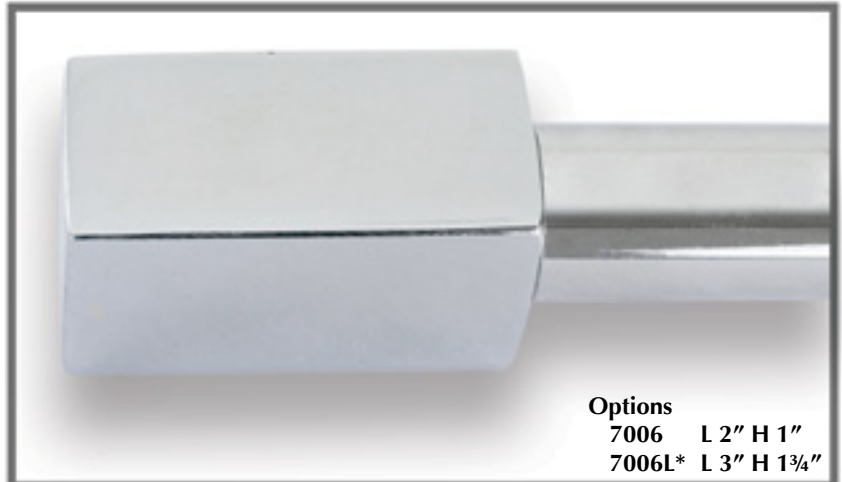

Options  
 7006 L 2" H 1"  
 7006L\* L 3" H 1 3/4"

Finial: 7006  
 Finish: Polished Chrome

L 2" H 1"

# *New Finial Designs*

## *3 New Designs for the Italian Collection*

We've expanded our Italian Collection with three new finial designs for you to choose from. These modern styles combine the sleek sophistication of plated metal with the timelessness of wood. Finials are available in two different sizes. Choose from six Italian finishes for the metal and three wood finishes for the insert. Interior fit only. Available for 3/4", 1" and 1 1/4" diameter rods. Not available for Traversing Rods.



**Finial 7070L**  
 3 3/4" Long x 1 3/8" High  
 Shown in Polished Chrome (IT 206) on a 1" round rod with Walnut stained wood insert.



**Finial 7070**  
 3 3/8" Long x 1" High  
 Shown in Brushed Nickel (IT 201) on a 1" round rod with Oak stained wood insert.

### Horizontal Lines



**Finial 7071L**  
 3 3/4" Long x 1 3/8" High  
 Shown in Polished Chrome (IT 206) on a 1" round rod with Natural stained wood insert.



**Finial 7071**  
 3 3/8" Long x 1" High  
 Shown in Brushed Nickel (IT 201) on a 1" round rod with Walnut stained wood insert.

### Slat Lines



**Finial 7072L**  
 3 3/4" Long x 1 3/8" High  
 Shown in Polished Chrome (IT 206) on a 1" round rod with Oak stained wood insert.



**Finial 7072**  
 3 3/8" Long x 1" High  
 Shown in Brushed Nickel (IT 201) on a 1" round rod with Natural stained wood insert.

### Wavy Lines

## AVAILABLE WOOD INSERT FINISHES



Natural



Oak



Walnut

# Italian Collection

## Metal Plated Iron Drapery Hardware



**ROUND RODS**  
7019 3/4" DIA • 7020 1" DIA • 7023 1 1/4" DIA  
(Shown in Brushed Nickel)

**SQUARE RODS**  
7021 3/4" DIA • 7022 1" DIA • 7024 1 1/4" DIA  
(Not Shown)



**321 END CAPS**  
(Left: Polished Chrome  
Right: Brushed Nickel)



**7016 END CAPS**  
Available for Round or Square Rods  
(Left: Brushed Nickel  
Right: Polished Chrome)



**7007**  
**ROD WITH RETURNS**  
3/4" or 1" Round or Square Rod  
Standard Projection 3" & 6"  
(Shown in Brushed Nickel)

**1014**  
**BATON**  
Specify Ring or Clip  
(Shown in Polished Chrome)



**7014**  
**3" P SINGLE BRACKET**  
Available for Round  
or Square Rods  
(Shown in  
Polished Chrome)



**7035**  
**SINGLE CEILING  
MOUNT BRACKET**  
Available for Round  
or Square Rods  
(Shown in Brushed Nickel)



**7015**  
**6" P SINGLE  
BRACKET**  
Available for Round  
or Square Rods  
(Shown in Polished  
Chrome)



**7036**  
**DOUBLE CEILING  
MOUNT BRACKET**  
(Shown in Brushed  
Nickel)



**7012**  
(Shown in  
Brushed Nickel)



**7040**  
**3" & 6" P DOUBLE  
BRACKET**  
Available for Round  
or Square Rods  
(Shown in Polished  
Chrome)



**7038**  
**3" P EYELET BRACKET**  
(Shown in Brushed Nickel)

**7039**  
**6" P EYELET BRACKET**  
(Not Shown)



**7013**  
(Shown in  
Polished Chrome)



**7010 SOCKETS**  
Available for Round  
or Square Rods  
(Left: Brushed Nickel  
Right: Polished Chrome)



**7011 SOCKETS**  
Available for Round  
or Square Rods  
(Left: Brushed Nickel  
Right: Polished Chrome)



45°



90°

**7009**  
Available for Round or Square Rods  
(Shown in Brushed Nickel)



**7017**  
**CORNER BRACKET**  
(Shown in Brushed Nickel)



**7018**  
**MOVABLE ELBOW**  
Shown in 3/4"; Interior Fit Only  
(Shown in Polished Chrome)

# Unique Collection: Italian By Pass System with "C" Rings

Available in 3/4", 1" and 1 1/4" diameters. Straight Round Hollow Rods only.  
Available in all Iron Art™ and Italian Collection finishes. Shown in Brushed Nickel.

## RINGS



**7330C**  
"C" RING  
(Shown in  
Polished Chrome)



Single Rod System

Double Rod System

## BRACKETS



**7014SE**  
3"P SINGLE  
END BRACKET



**7015SE**  
6"P SINGLE  
END BRACKET



**7040DE**  
3" & 6"P  
DOUBLE END  
BRACKET



**7318-3P**  
3"P SINGLE  
SUPPORT  
BRACKET



**7318-6P**  
6"P SINGLE  
SUPPORT  
BRACKET



**7319**  
3" & 6"P  
DOUBLE  
SUPPORT  
BRACKET

## ITALIAN FINISHES



**8014**  
Italian Finish Selector Set  
All six finishes in a plastic  
binder sleeve



Brushed Nickel  
IT 201 - Group I



Polished Chrome  
IT 206 - Group J



Black Nickel  
IT 202 - Group K



Oiled Bronze  
IT 203 - Group K

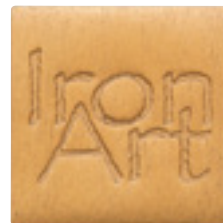

Satin Copper  
IT 204 - Group K



Satin Gold  
IT 205 - Group K

# Bohemia Collection

## Decorative Hand Crafted Faceted Crystal-Glass Finials\*

All Finials: Interior fit only. Available to fit 3/4", 1" and 1 1/4" diameter, Round and Square Hollow Iron Rods or 1 1/2" Traversing Rods.



\*One of the hallmarks of true faceted crystal-glass is that it shows changes and variations in color when viewed from different angles.

# Bohemia Collection

## Decorative Hand Crafted Faceted Crystal-Glass Finials\*

All Finials: Interior fit only. Available to fit 3/4", 1" and 1 1/4" diameter, Round and Square Hollow Iron Rods or 1 1/2" Traversing Rods.



780  
L 3" H 3 1/8"  
Rod Finish: Brown



All Bohemia Finials are shipped in custom boxes to ensure high quality protection.



781  
L 2 1/8" H 2 3/8"  
Rod Finish: Antique White



785  
L 2 1/2" H 1 1/2"  
Rod Finish: Polished Chrome



789  
L 3/4" H 2"  
Rod Finish: New Nickel



782  
L 2 7/8" H 2 3/4"  
Rod Finish: Antique Bronze



786  
L 3" H 2 3/8"  
Rod Finish: Bronze Vecchio



790  
L 3/4" H 2"  
Rod Finish: Antique Gold



783  
L 1 7/8" H 2"  
Rod Finish: Rich Gold



787  
L 3 1/2" H 2"  
Rod Finish: Soft Pewter



791  
L 3 5/8" H 3 5/8"  
Rod Finish: Naturelle



784  
L 2 3/8" H 2 7/8"  
Rod Finish: Old Black



788  
L 3 1/2" H 2"  
Rod Finish: Black



792  
L 3 3/4" H 3 1/4"  
Rod Finish: Brushed Nickel

\*One of the hallmarks of true faceted crystal-glass is that it shows changes and variations in color when viewed from different angles.

# Bohemia on Wood Collection

## Decorative Hand Crafted Faceted Crystal-Glass Finials\*

Available to fit 1 3/8" diameter Wood Poles.

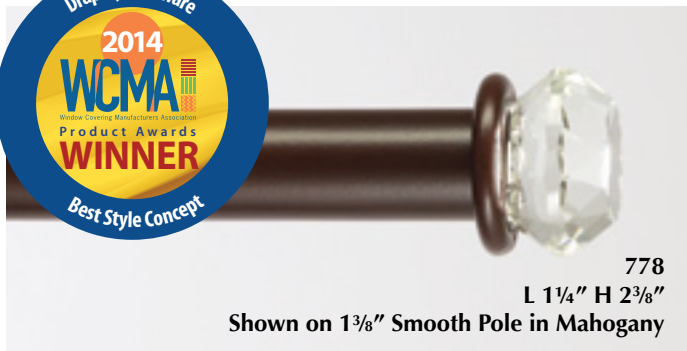

778  
L 1 1/4" H 2 3/8"  
Shown on 1 3/8" Smooth Pole in Mahogany



790  
L 3/4" H 2"  
Shown on 1 3/8" Smooth Pole in Mahogany

Available to fit 1 3/8", 2" and 2 1/4" diameter Wood Poles, or 2" and 2 1/2" Traversing Poles.



771  
L 2 3/8" H 2 1/4"  
Shown on 2" Rope Pole in Naturelle

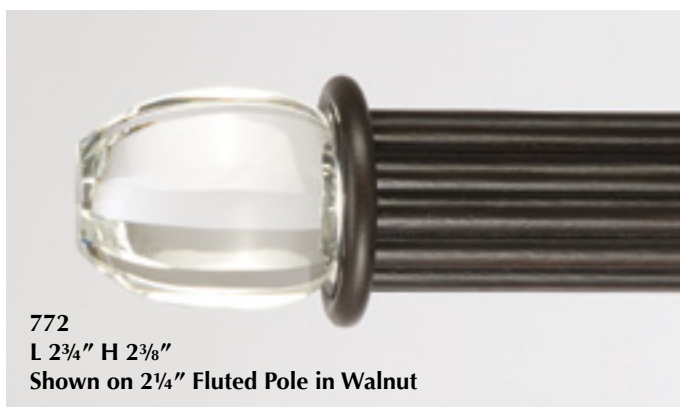

772  
L 2 3/4" H 2 3/8"  
Shown on 2 1/4" Fluted Pole in Walnut



773  
L 2 3/4" H 2 3/8"  
Shown on 2 1/4" Fluted Pole in Walnut



774  
L 2" H 2 3/4"  
Shown on 2" Smooth Pole in Burnt Gold



775  
L 2 3/4" H 2 1/2"  
Shown on 2" Rope Pole in Naturelle



776  
L 2 3/8" H 3 1/8"  
Shown on 2" Smooth Pole in Burnt Gold

\*One of the hallmarks of true faceted crystal-glass is that it shows changes and variations in color when viewed from different angles.



# Bohemia on Wood Collection

## Decorative Hand Crafted Faceted Crystal-Glass Finials\*

Available to fit 1 $\frac{3}{8}$ ", 2" and 2 $\frac{1}{4}$ " diameter Wood Poles, or 2" and 2 $\frac{1}{2}$ " Traversing Poles.

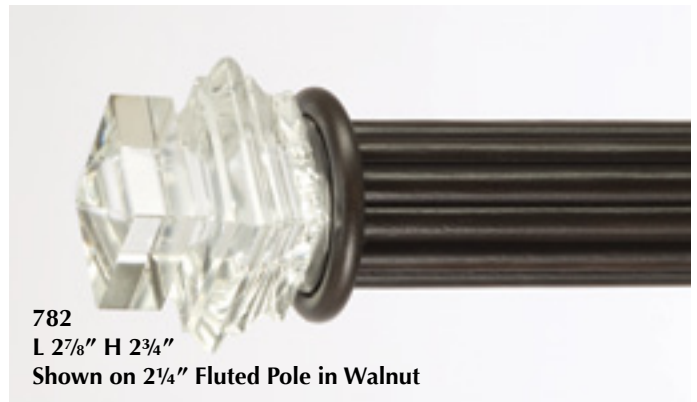

\*One of the hallmarks of true faceted crystal-glass is that it shows changes and variations in color when viewed from different angles.

# Wood Craft Collection

## Hand-Carved Finials

Available in Iron Art and Wood Art Finishes. Available While Supplies Last.

FINIALS TO FIT 1<sup>3</sup>/<sub>8</sub>" and 2" WOOD POLES

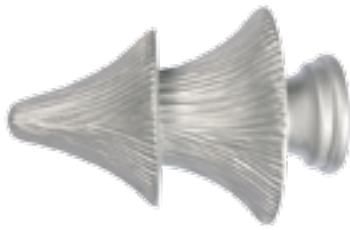

**CHINOISE**  
5060 16<sup>1</sup>/<sub>2</sub>" H14"  
Shown in New Nickel



**SCALLOP**  
5061 15<sup>1</sup>/<sub>2</sub>" H15<sup>1</sup>/<sub>4</sub>"  
Shown in Burnt Silver



**HALLARD**  
5062 16<sup>1</sup>/<sub>2</sub>" H13<sup>1</sup>/<sub>4</sub>"  
Shown in Sage Gold



**HAMPTON**  
5063 16" H12<sup>1</sup>/<sub>2</sub>"  
Shown in Natural



**TOWER**  
5064 16" H13"  
Shown in Antique White



**BALL**  
5065 15<sup>1</sup>/<sub>2</sub>" H14"  
Shown in Natural



**DAFFODIL**  
5066 15<sup>1</sup>/<sub>2</sub>" H13<sup>1</sup>/<sub>4</sub>"  
Shown in Dusk Black



**LILIUM**  
5067 16" H15"  
Shown in Dusk Black

FINIALS TO FIT 2" and 2<sup>1</sup>/<sub>4</sub>" WOOD POLES



**DAHLIA**  
5080 16<sup>1</sup>/<sub>4</sub>" H16"  
Shown in Antique Bronze



**SEPHORA**  
5081 16<sup>1</sup>/<sub>4</sub>" H17"  
Shown in Dusk Black High Gloss



**DICO**  
5082 16<sup>1</sup>/<sub>4</sub>" H17"  
Shown in Dusk Black High Gloss



**IRIS**  
5083 16<sup>1</sup>/<sub>4</sub>" H14<sup>1</sup>/<sub>2</sub>"  
Shown in Burnt Gold



**STRATA**  
5084 17" H13<sup>1</sup>/<sub>4</sub>"  
Shown in Aged Pewter



**IMPERIAL**  
5085 17" H14"  
Shown in Light Cherry



**TIFFANY**  
5086 15" H14"  
Shown in Imitation Gold Leaf



**REGENCY**  
5088 16<sup>1</sup>/<sub>4</sub>" H14"  
Shown in Mahogany

# Wood Craft Collection

## Hand-Carved Swag Holders, Brackets, Batons

Tiebacks available as "U" Shape Bend or with Post Projection.  
Available in Iron Art and Wood Art Finishes. Available While Supplies Last.



**DAHLIA TIEBACK**  
5095 14<sup>1</sup>/<sub>8</sub>" H16"  
Shown in Rich Gold



**BALI TIEBACK**  
5096 4<sup>3</sup>/<sub>8</sub>" DIA  
Shown in Antique Copper



**MING TIEBACK**  
5097 4<sup>1</sup>/<sub>2</sub>" DIA  
Shown in Light Brown



**TIFFANY TIEBACK**  
5098 4<sup>1</sup>/<sub>2</sub>" DIA  
Shown in Soft Pewter



**IRIS ACCENT TIEBACK**  
5099 4<sup>1</sup>/<sub>2</sub>" DIA  
Shown in Dark Brown



5071  
L38"  
3/8" DIA

CLOSE VIEW OF HANDLE

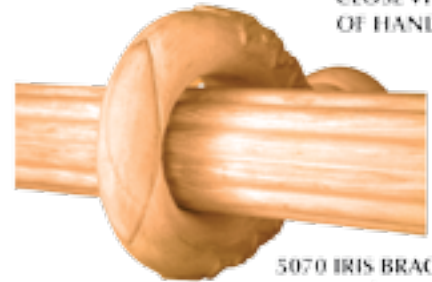

**5070 IRIS BRACKET**  
P6<sup>3</sup>/<sub>4</sub>"  
Bracket 2" Pole only  
Shown in Unfinished

## Wood Poles & Accessories

Poles and accessories available with 1<sup>3</sup>/<sub>8</sub>", 2", 2<sup>1</sup>/<sub>4</sub>" and 3" diameters (unless mentioned otherwise).

SMOOTH



FLUTED



ROPE



Clip only

AMERICAN STYLE WOOD BRACKETS



5045S  
P4"

5045E  
P7"



**5051 STANDARD SOCKET PAIR**  
Shown as 1<sup>3</sup>/<sub>8</sub>", Not available for 3" Pole

EUROPEAN STYLE WOOD BRACKETS



5046S  
P4"

5046E  
P7"

5047 SMOOTH  
1/2" Thick for  
1<sup>3</sup>/<sub>8</sub>", 2" and 2<sup>1</sup>/<sub>4</sub>" Poles.  
Not available for 3" Pole.

5049 FLUTED  
1/2" Thick

5048 SMOOTH  
7/8" Thick for 3" Pole only

**5050 SWIVEL MOVABLE ELBOW**  
Shown as 1<sup>3</sup>/<sub>8</sub>", Not available for 3" Pole

5052  
END CAP

5056  
METAL CONNECTOR  
FOR WOOD POLES

5053 BATON  
L38" DIA 1/2"

# Rosina Collection

## Decorative Resin Finials

To fit 1 3/8" Wood Poles.



Finial : 6003  
Finish : 05 AUTUMN  
L5 1/4" H4"



Finial : 6004  
Finish : 07 RICH GOLD  
L1 1/4" H2 1/4"



Finial : 6008  
Finish : 03 NATURELLE  
L5 1/2" H3"

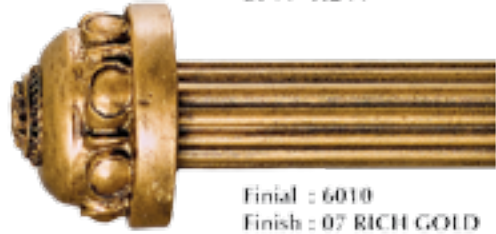

Finial : 6010  
Finish : 07 RICH GOLD  
L2" H3"



Finial : 6022  
Finish : 20 ANT. WHITE  
L3 1/4" H2"



Finial : 6023  
Finish : 20 ANT. WHITE  
L4" H2 1/4"

To fit 2" and 2 1/4" Wood Poles.



Finial : 6000  
Finish : 18 RENAISSANCE SILVER  
L5 1/2" H4"



Finial : 6001  
Finish : 18 RENAISSANCE SILVER  
L6 1/4" H3 1/2"



Finial : 6002  
Finish : 26 BRONZE PATINA  
L4 1/4" H3"



Finial : 6005  
Finish : 24 SAGE GOLD  
L6 1/4" H5 1/4"



Finial : 6006  
Finish : 24 SAGE GOLD  
L8" H4 1/2"



Finial : 6007  
Finish : WC 103 MAHOGANY  
L6" H4"

# Rosina Collection

## Decorative Resin Finials

To fit 2" and 2 1/4" Wood Poles.



Finial : 6009  
Finish : 05 AUTUMN  
L6" H3 1/4"



Finial : 6011  
Finish : 15 BRONZE VECCHIO  
L6" H3"



Finial : 6012  
Finish : 28 VECCHIO PATINA  
L6 1/2" H3 1/4"



Finial : 6013  
Finish : WC 103 MAHOGANY  
L6" H3 1/4"



Finial : 6014  
Finish : 15 BRONZE VECCHIO  
L6" H3 1/4"



Finial : 6015  
Finish : 28 VECCHIO PATINA  
L6 1/4" H3"



Finial : 6016  
Finish : 26 BRONZE PATINA  
L5" H2 1/4"



Finial : 6017  
Finish : 03 NATURELLE  
L5" H3"



Finial : 6020  
Finish : 29 GOLDEN OAK  
L4 1/4" H2 3/4"



Finial : 6019  
Finish : 29 GOLDEN OAK  
L6" H3"

# New York Wood Collection

## Exclusive Hand-Painted Wood Finials

Wood Art™ by Orion proudly presents this collection of Wood Finials that fit 1 3/8", 2", 2 1/4" & 3" Wood Poles.  
Each item is finished by our artisans to create an impeccable look.  
Available in Iron Art and Wood Art Finishes.

### FINIALS TO FIT 1 3/8" WOOD POLES



**ACORN**

5040 14 1/2" H2"

Shown in WC 110 Golden Teak High Gloss



**FLUTED**

5041 13 3/4" H2"

Shown in WC 104 White Wash



**BALL**

5042 13" H2"

Shown in WC 104 White Wash



**DIAMOND**

5043 13 1/2" H2 1/4"

Shown in WC 110 Golden Teak High Gloss

### FINIALS TO FIT 2", 2 1/4" & 3" WOOD POLES



**ORNATE FLUTE**

5020 14 1/2" H3" for 2" & 2 1/4" Wood Poles

5030 15" H3 1/2" for 3" Wood Poles

Shown in 5020, WC 101 Light Cherry



**SAXON**

5021 16 1/2" H2 3/4" for 2" & 2 1/4" Wood Poles

5031 16 3/4" H3 1/2" for 3" Wood Poles

Shown in 5031, WC 107 White Distress



**CUP**

5022 15" H2 1/2" for 2" & 2 1/4" Wood Poles

5032 15 1/2" H3 1/2" for 3" Wood Poles

Shown in 5022, WC 107 White Distress



**WINDSOR**

5023 15 1/2" H3" for 2" & 2 1/4" Wood Poles

5033 16 1/2" H3 3/4" for 3" Wood Poles

Shown in 5023, WC 101 Mahogany



**DECORATIVE ACORN**

5024 15 1/2" H3" for 2" & 2 1/4" Wood Poles

5034 15 1/2" H3 1/2" for 3" Wood Poles

Shown in 5024, WC 106 Walnut High Gloss



**DESIGNER BALL**

5025 14 1/4" H3" for 2" & 2 1/4" Wood Poles

5035 15 1/2" H3 1/2" for 3" Wood Poles

Shown in 5025, WC 111 Sun Oak



**YORK**

5026 16" H3" for 2" & 2 1/4" Wood Poles

5036 16 3/4" H3 1/2" for 3" Wood Poles

Shown in 5026, WC 106 Walnut High Gloss



**TUDOR**

5027 16" H3" for 2" & 2 1/4" Wood Poles

5037 16" H3 1/2" for 3" Wood Poles

Shown in 5027, WC 111 Sun Oak



**WOOD BALL**

5028 15" H3 1/2" for 2" & 2 1/4" Wood Poles

5038 17" H4 1/2" for 3" Wood Poles

Shown in 5028, WC 106 Walnut

# Promotional Items



**8000 - IRON ART PRODUCT WALL DISPLAY - SET ONE**  
L32" H48"



**8001 - IRON ART PRODUCT WALL DISPLAY - SET TWO**  
L32" H48"



**8002 - XPRESS YOURWAY QUICK SHIP WALL DISPLAY**  
L32" H48"



**8010 - DESIGNER PRODUCT CASE**  
L20" W15" H7" Weight 18 lbs.  
Includes #8008 - Color Selectors in Binder



**8003**  
DESIGNER  
FINIAL SET  
6 Finial with  
Rod Samples



**8011 - DESIGNER SAMPLE KIT**  
L20" W15" H5" Weight 11 lbs.



**8006 - TROPICAL (BAMBOO) FINISH SELECTOR SET**  
All 6 finishes on a metal ring



**8004 - IRON ART™ FINISH SELECT SET**  
All 35 finishes in plastic binder sleeves

**8005 - WOOD ART™ FINISH SELECT SET**  
All 11 finishes in a plastic binder sleeve

**8014 - ITALIAN FINISH SELECTOR SET**  
All 6 finishes in a plastic binder sleeve

**8008 - COLOR SELECTOR SETS IN BINDER**  
Iron Art™, Wood Art™ and Italian  
Collection Finish Selectors

**8009 - CATALOG & PRICE LIST SET**

**8015 - Binder Plus Catalog and Price List**



**8016**  
SINGLE SQUARE COLOR  
SELECTOR CHIP

Also available in Semi or High Gloss Finishes. Please add 20% upcharge.

# Iron Art Finishes

## IRON ART FINISHES: A



09 Light Brown



14 Black



19 Brown

## IRON ART FINISHES: B



01 Old Black



02 Antique Bronze



03 Naturelle



04 Rusty



06 Antique Gold



07 Rich Gold



10 Antique Copper



12 New Nickel



13 Soft Pewter



15 Bronze Vecchio



17 Burnt Silver



20 Antique White



32 Ivory



33 Pure White



34 Oil Rubbed Bronze



35 Metal Ore

Please note the finishes presented above are lithographic reproductions of Orion's actual finishes, and as such may not accurately reflect the true depth and tone of our finishes. Please always refer to actual Orion finish samples before ordering our products.



# Iron Art Finishes

## IRON ART FINISHES: C

Also available in  
Semi or High Gloss  
Finishes. Please add  
20% upcharge.



11 Versace



16 Gold Antique White



18 Renaissance Silver



24 Sage Gold



25 Burnt Gold



26 Bronze Patina



27 Cherry Gold



28 Vecchio Patina



29 Golden Oak

## IRON ART FINISHES: D



05 Autumn



08 Imposter



21 Crackle



22 Antique Crackle



23 Mocha Mix



30 Warm Cherry



31 Sugar Maple

Please note the finishes presented above are lithographic reproductions of Orion's actual finishes, and as such may not accurately reflect the true depth and tone of our finishes. Please always refer to actual Orion finish samples before ordering our products.

*... always leaves a lasting impression!*

# Wood Art Finishes

## WOOD ART HAND STAINS : E



WC 101 Light Cherry



WC 102 Natural



WC 103 Mahogany



WC 104 White Wash



WC 105 Dusk Black



WC 106 Walnut

## WOOD ART HAND STAINS : F



WC 107 White Distress

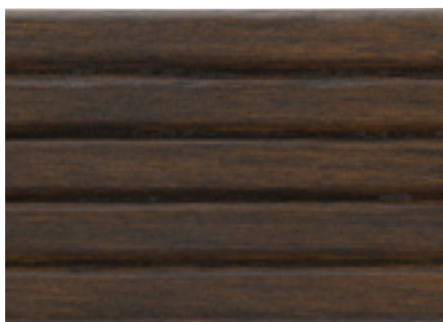

WC 108 Aged Pewter

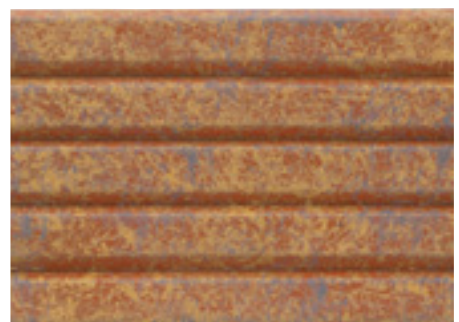

WC 109 Imitation Gold Leaf

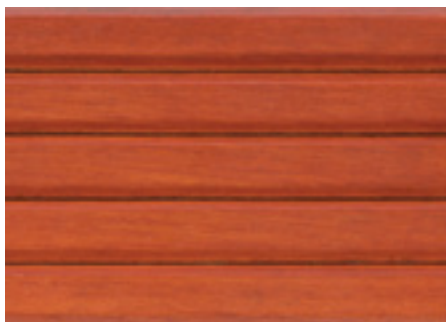

WC 110 Golden Teak



WC 111 Sun Oak

Also available in  
Semi or High Gloss  
Finishes. Please add  
20% upcharge.

Please note the finishes presented above are lithographic reproductions of Orion's actual finishes, and as such may not accurately reflect the true depth and tone of our finishes. Please always refer to actual Orion finish samples before ordering our products.

# Measurement Guidelines



**FINIAL 501**  
L = Length  
H = Height  
*Interior Fit*

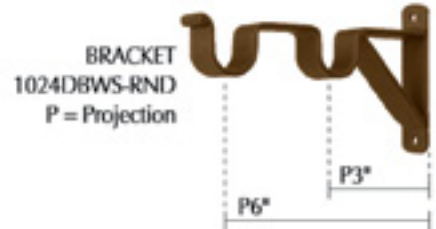

**BRACKET 1024DBWS-RND**  
P = Projection



**FINIAL 991**  
L = Length  
H = Height  
*Exterior Fit*

**DECORATIVE CORNICE BAMBOO 9040**  
H = Height  
L = Length  
P = Projection  
WD = Wood Duster

**BRACKET 102B-RND**  
P = Projection



**WOOD BRACKET AMERICAN 5045S**  
P = Projection

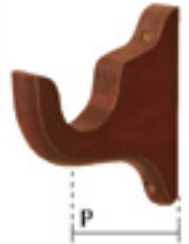

**DECORATIVE ROD 254**  
H = Height D = Diameter



**RING 350**  
ID = Internal Diameter  
T = Thickness



**DECORATIVE ROD 280**  
L = Length

IRON RODS

WOOD RODS

D = Diameter



**IRON SQUARE ROD**



**DECORATIVE SCROLL 267**  
L = Overall Length  
LH = Length of Head  
HH = Height of Head

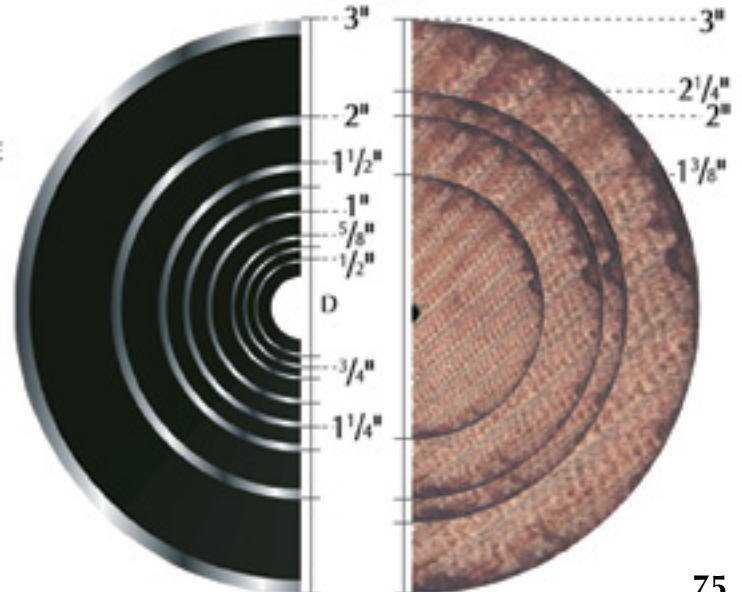
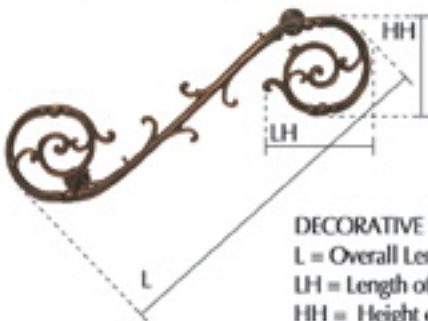

# ORION

ORNAMENTAL IRON, INC.



Fall 2014